



# Operation & Maintenance Manual

## Three-Point Finish Mower

---



---

**MOWER 3 PT (FM60) S/N B65R00101 & Above**  
**MOWER 3 PT (FM72) S/N B65S00101 & Above**





# OPERATOR SAFETY WARNINGS



## WARNING

Operator must have instructions before operating the machine. Untrained operators can cause injury or death.

W-2001-0502



**Safety Alert Symbol:** This symbol with a warning statement, means: Warning, be alert! Your safety is involved! Carefully read the message that follows.

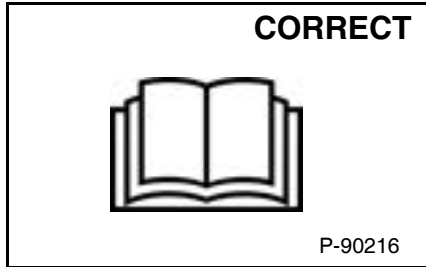

- ⚠ Never use the three-point finish mower without instructions. See machine signs (decals), Operation & Maintenance Manual, and Operator's Handbook.

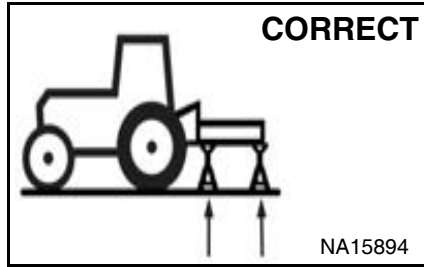

- ⚠ Securely block up the implement before working underneath.

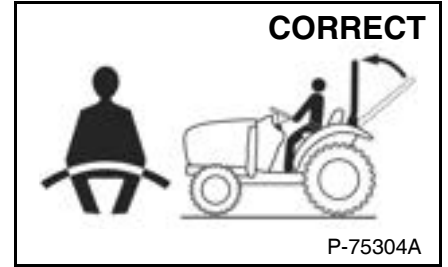

- ⚠ Fasten seat belt securely when Roll-Over Protective Structure (ROPS) is up and locked.
- ⚠ DO NOT wear seat belt if ROPS is down.

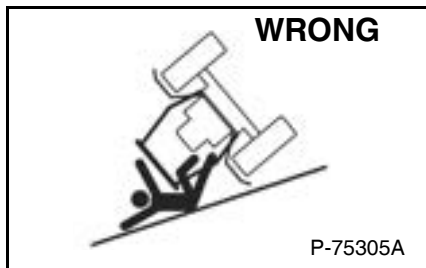

- ⚠ USE ROPS AND FASTEN SEAT BELT.
- ⚠ Always check work area before operating three-point finish mower.

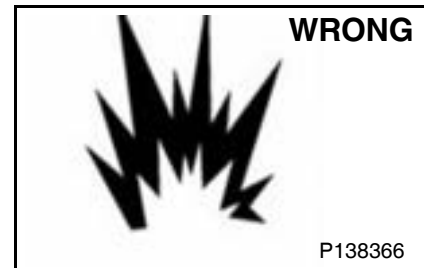

- ⚠ Do not use compact tractor or three-point finish mower in atmosphere with explosive dust, explosive gas, or where exhaust can contact flammable material.

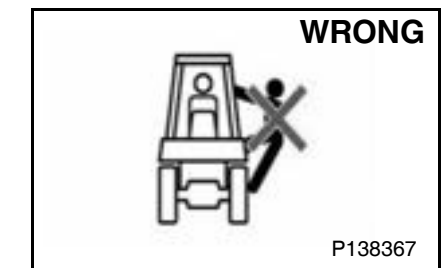

- ⚠ Never allow riders on equipment.
- ⚠ Keep bystanders away when operating.



- ⚠ Keep PTO master shield, implement shield, and driveline guards in place.
- ⚠ Keep away from moving parts.
- ⚠ Only operate from the operator's position.

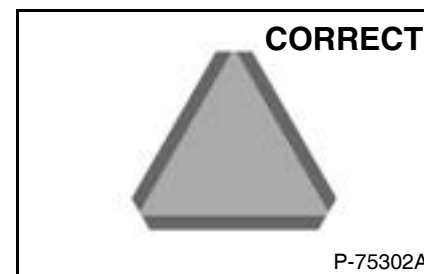

- ⚠ Obey all traffic regulations when on public roads. Use slow moving vehicle (SMV) emblem and hazard flashers when required.
- ⚠ Lock brake pedals together (if equipped) for road travel.

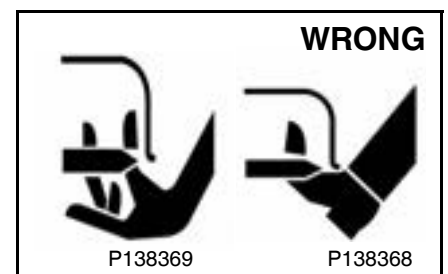

- ⚠ Do not put hands, feet, or objects under three-point finish mower when engine is running.
- ⚠ To park, engage PARKING BRAKE, put all controls in NEUTRAL, move PTO lever(s) to OFF, put attachment and implement flat on the ground and stop engine.

## SAFETY EQUIPMENT

The Compact Tractor and Three-Point Finish Mower Implement must be equipped with safety items necessary for each job. Ask your dealer about implements and accessories.

1. SEAT BELT: Check belt fasteners and check for damaged webbing or buckle.
2. OPERATOR CAB (ROPS): It must be on the compact tractor with all fasteners tight.
3. MACHINE AND IMPLEMENT SAFETY SIGNS (DECALS): Replace if damaged.
4. COMPACT TRACTOR PTO SHIELD: Replace if damaged.
5. PARKING BRAKE.
6. IMPLEMENT PTO SHIELD: Replace if damaged.
7. PTO DRIVELINE GUARD: Replace if damaged.



## CONTENTS

FOREWORD .....	3
SAFETY & TRAINING RESOURCES .....	9
OPERATING INSTRUCTIONS .....	17
PREVENTIVE MAINTENANCE .....	43
SPECIFICATIONS .....	65
WARRANTY .....	69
ALPHABETICAL INDEX .....	73



## FOREWORD

This Operation & Maintenance Manual was written to give the owner / operator instructions on the safe operation and maintenance of the Ignite three-point mower. READ AND UNDERSTAND THIS OPERATION & MAINTENANCE MANUAL BEFORE OPERATING YOUR IGNITE THREE-POINT MOWER. If you have any questions, contact your Ignite Attachments representative. This manual may illustrate options and accessories not installed on your three-point mower.

MANUFACTURER .....	5
North America .....	5
SERIAL NUMBER LOCATION .....	5
Implement Serial Number .....	5
IMPLEMENT IDENTIFICATION .....	6
FEATURES AND ACCESSORIES .....	7
Standard Items .....	7



## MANUFACTURER

### North America

Ignite Attachments  
2741 20th Avenue South  
Moorhead, MN 56560

## SERIAL NUMBER LOCATION

### Implement Serial Number

Figure 1

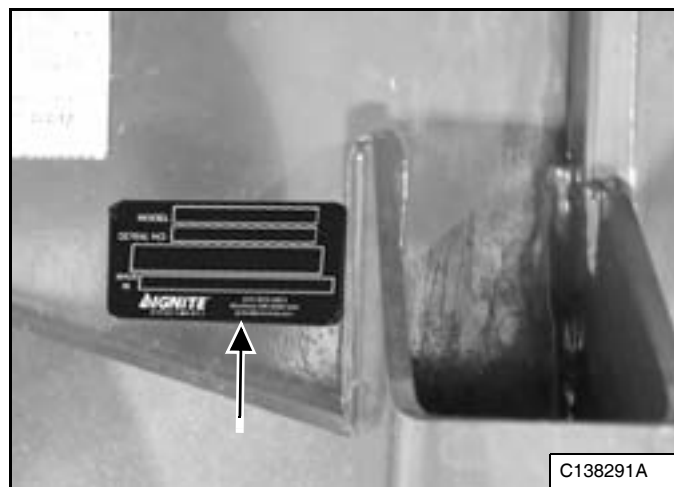

Always use the serial number of the mower when requesting service information or when ordering parts. Earlier or later models (identification made by serial number) may use different parts, or it may be necessary to use a different procedure in doing a specific service operation [Figure 1].

**IMPLEMENT IDENTIFICATION**

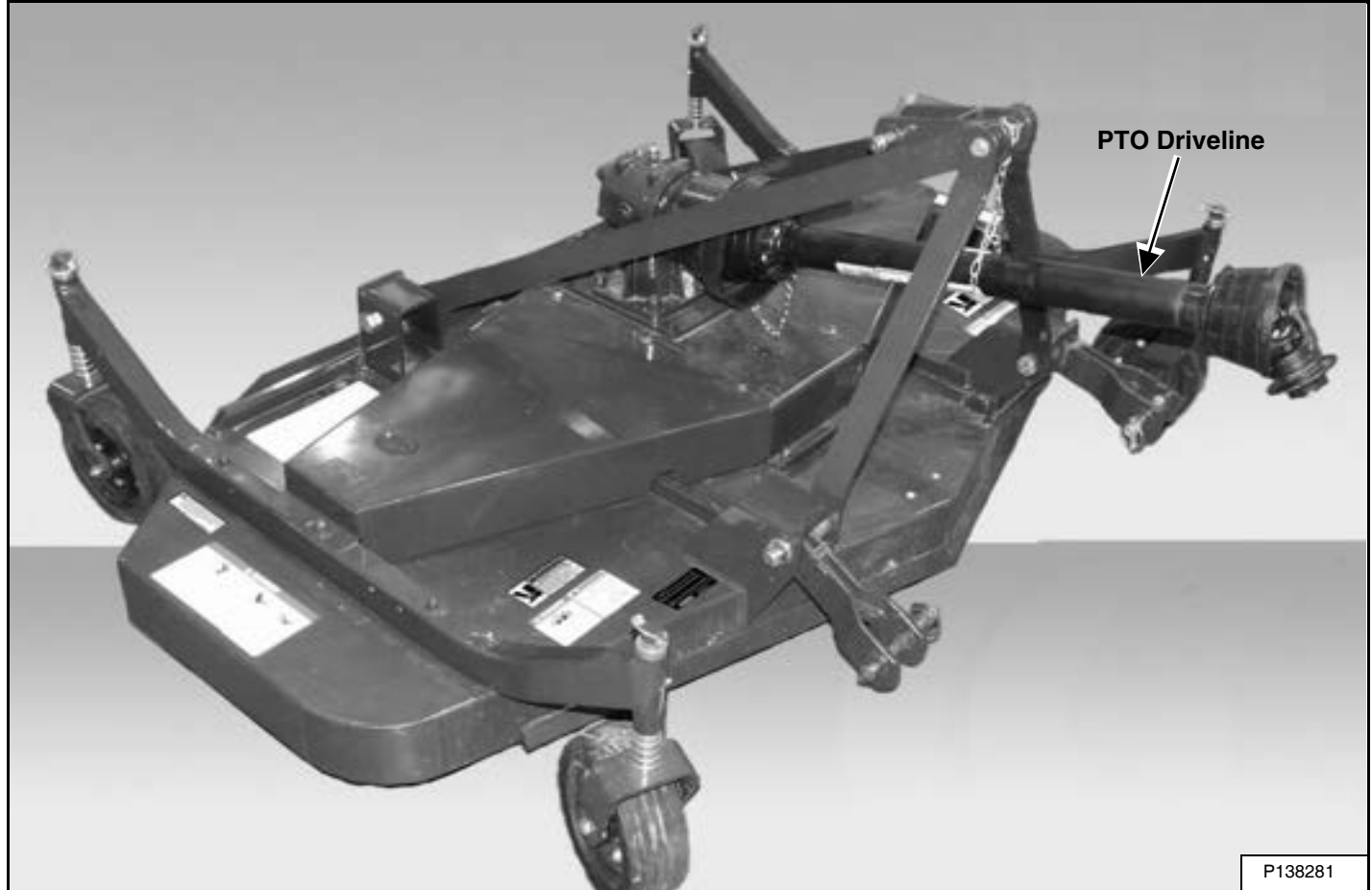
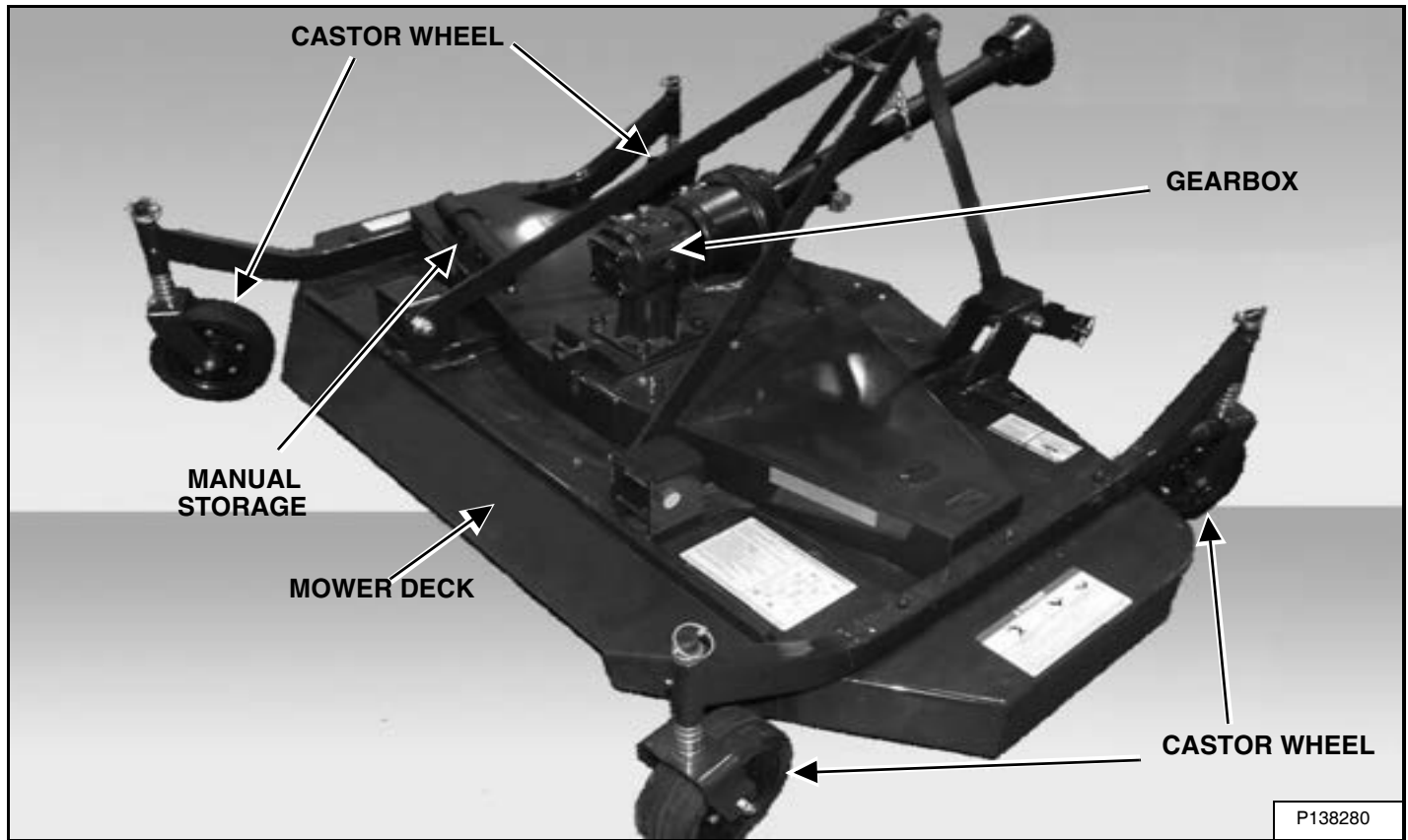

## **FEATURES AND ACCESSORIES**

### **Standard Items**

The mower is equipped with the following standard items:

- Cutting Height Adjusts From 25 mm (0.98 in) to 97 mm (3.82 in) in 13 mm (0.50 in) increments.
- Cutting Widths Of 1500 mm (59.05 in) And 1800 mm (70.87 in).
- Three Overlapping Blades.
- Implement Frame Oscillates Independently.
- Anti-Scalping Wheel To Traverse Terrain Without Scalping.
- Rear Discharge



## **SAFETY & TRAINING RESOURCES**

SAFETY INSTRUCTIONS .....	11
Safe Operation Is The Operator's Responsibility .....	11
Safe Operation Needs A Qualified Operator .....	11
Use Safety Rules .....	11
Call Before You Dig .....	12
Avoid Silica Dust .....	12
Safety Rules For Power Take-Off (PTO) Driven Implements .....	12
Machine Requirements And Capabilities .....	12
FIRE PREVENTION .....	13
Maintenance .....	13
Operation .....	13
Electrical .....	13
Hydraulic System .....	14
Fueling .....	14
Starting .....	14
Spark Arrester Exhaust System .....	14
Welding And Grinding .....	14
Fire Extinguishers .....	14
PUBLICATIONS AND TRAINING RESOURCES .....	15
ATTACHMENT SIGNS (DECALS) .....	16



## SAFETY INSTRUCTIONS

### Safe Operation Is The Operator s Responsibility



The signal word **DANGER** on the machine and in the manuals indicates a hazardous situation which, if not avoided, will result in death or serious injury.



The signal word **WARNING** on the machine and in the manuals indicates a potentially hazardous situation which, if not avoided, could result in death or serious injury.



This notice identifies procedures which must be followed to avoid damage to the machine.

The machine and implement must be in good operating condition before use.

Check all of the items on the Service Schedule decal (if equipped) in the Every 10 Hours section or as shown in the Operation & Maintenance Manual.

### Safe Operation Needs A Qualified Operator

For an operator to be qualified, he or she must not use drugs or alcoholic drinks which impair alertness or coordination while working. An operator who is taking prescription drugs must get medical advice to determine if he or she can safely operate a machine.

## Use Safety Rules

- Read and follow instructions in the machine and the implement's Operation & Maintenance Manual before operating.
- Check for underground lines before operating implement (if applicable).
- In addition to the design and configuration of equipment, hazard control, and accident prevention are dependent upon the awareness, concern, prudence, and proper training of personnel involved in the operation, transport, maintenance, and storage of equipment.
- Check that the implement is securely fastened to the machine.
- Make sure all the machine controls are in the neutral position before starting the machine.
- Operate the implement only from the operator's position.
- Operate the implement according to the Operation & Maintenance Manual.
- When learning to operate the implement, do it at a slow rate in an area clear of bystanders.
- DO NOT permit personnel to be in the work area when operating the machine and implement.
- The implement must be used ONLY on approved machines. Visit [igniteattachments.com](http://igniteattachments.com) for an updated list of approved implements for each machine model.
- DO NOT modify equipment or add implements that are not approved by the manufacturer.
- DO NOT make any adjustments or repairs on the machine or implement while the engine is running.
- Keep shields and guards in place. Replace if damaged.

## Call Before You Dig



Dial 811 (USA Only)

1-888-258-0808 (USA & Canada)

When you call, you will be directed to a location in your state / province / city for information about buried lines (telephone, cable TV, water, sewer, gas, etc.).

## Avoid Silica Dust



Silica dust can cause lung disease and is known to the state of California to cause cancer.

Cutting or drilling concrete containing sand or rock containing quartz may result in exposure to silica dust.

Do not exceed Permissible Exposure Limits (PEL) to silica dust as determined by OSHA or other job site Rules and Regulations. Use a respirator, water spray, or other means to control dust.

## Safety Rules For Power Take-Off (PTO) Driven Implements

- Keep power take-off (PTO) shields and all guards in place. Replace damaged or missing shields and guards before operating.
- Follow warnings and instructions on machine signs (decals). Replace damaged or missing decals.
- Do not wear loose or bulky clothing around the PTO or other moving parts.
- Keep bystanders away from PTO driven equipment,

and never allow children near machines.

- Read and understand manuals for the PTO driven equipment and be aware of safe operating procedures and hazards that may not be readily apparent.
- Always walk around equipment to avoid coming near a turning PTO driveline. Stepping over, leaning across or crawling under a turning PTO driveline can cause entanglement.
- Position the machine and attachment hitch correctly to prevent driveline stress and separation.
- Use caution when turning. Turning too sharp can cause driveline damage.
- Use caution when raising PTO driven attachment. Excessive driveline angle can cause driveline damage. Use stops if needed.

## Machine Requirements And Capabilities

- Fasten seat belt securely when ROPS is up and locked. DO NOT wear seat belt if ROPS is down.
- The machine must be equipped with sway bars or chains.
- Stop the machine and engage the parking brakes. Install blocks in front of and behind the rear tires of the machine. Install blocks underneath and support the implement securely before working under raised implements.
- Keep bystanders clear of moving parts and the work site. Keep children away.
- Use increased caution on slopes and near banks and ditches to prevent overturn.
- Make certain that the Slow Moving Vehicle (SMV) emblem is installed so that it is visible and legible. When transporting the equipment, use the machine flashing warning lights and follow all local regulations.
- Operate this equipment with approved ROPS. Always wear seat belt when the ROPS is up. Serious injury or death could result from falling off the machine.

- Before leaving the machine operator's seat:
  1. Park on flat level ground.
  2. Fully lower the loader arms and put the attachment flat on the ground (if equipped).
  3. Fully lower the three-point hitch or mid-mount implements (if equipped).
  4. Lock brake pedals together (if equipped) and engage the parking brake.
  5. Place all controls in neutral.
  6. Stop the engine, unfasten seat belt and remove the key.
- Never allow riders on the machine or implement. Falling off can result in serious injury or death.
- Start the machine only when properly seated in the operator's seat. Starting a machine in gear can result in serious injury or death.
- Operate the machine and attachments / implements from the operator's position only.
- Add the correct front ballast for rear three-point hitch implements and pull type implements. Add the correct rear ballast when using the loader and attachments. Contact your Ignite Attachments representative for available ballast options.
- Do not handle large objects (such as round bales or posts) unless the loader is equipped with the proper attachments and the load is secured.
- The parking brake must be engaged before leaving the machine operator's seat. Rollaway can occur because the transmission may not prevent machine movement. Lock the brake pedals together (if equipped) before activating the parking brake.

## FIRE PREVENTION



### Maintenance

The machine and some attachments have components that are at high temperatures under normal operating conditions. The primary source of high temperatures is the engine and exhaust system. The electrical system, if damaged or incorrectly maintained, can be a source of arcs or sparks.

Flammable debris (leaves, straw, etc.) must be removed regularly. If flammable debris is allowed to accumulate, it

can cause a fire hazard. Clean often to avoid this accumulation. Flammable debris in the engine compartment is a potential fire hazard.

The operator's area, engine compartment, and engine cooling system must be inspected every day and cleaned if necessary to prevent fire hazards and overheating.

All fuels, most lubricants, and some coolants mixtures are flammable. Flammable fluids that are leaking or spilled onto hot surfaces or onto electrical components can cause a fire.

### Operation

Do not use the machine where exhaust, arcs, sparks, or hot components can contact flammable material, explosive dust, or gases.

### Electrical



Check all electrical wiring and connections for damage. Keep the battery terminals clean and tight. Repair or replace any damaged part or wires that are loose or frayed.

Battery gas can explode and cause serious injury. Use the procedure in the Operation & Maintenance Manual for connecting the battery and for jump starting. Do not jump start or charge a frozen or damaged battery. Keep any open flames or sparks away from batteries. Do not smoke in battery charging area.

## Hydraulic System

Check hydraulic tubes, hoses and fittings for damage and leakage. Never use open flame or bare skin to check for leaks. Hydraulic tubes and hoses must be properly routed and have adequate support and secure clamps. Tighten or replace any parts that show leakage.

Always clean fluid spills. Do not use gasoline or diesel fuel for cleaning parts. Use commercial nonflammable solvents.

## Fueling



Stop the engine and let it cool before adding fuel. No smoking! Do not refuel a machine near open flames or sparks. Fill the fuel tank outdoors.

Ultra Low Sulfur Diesel (ULSD) poses a greater static ignition hazard than earlier diesel formulations with higher sulfur content. Avoid death or serious injury from fire or explosion. Consult with your fuel or fuel system supplier to ensure the delivery system is in compliance with fueling standards for proper grounding and bonding practices.

## Starting

Do not use ether or starting fluids on any engine that has glow plugs or an air intake heater. These starting aids can cause explosion and injure you or bystanders.

Use the procedure in the Operation & Maintenance Manual for connecting the battery and for jump starting.

## Spark Arrester Exhaust System

The spark arrester exhaust system is designed to control the emission of hot particles from the engine and exhaust system, but the muffler and the exhaust gases are still hot.

Check the spark arrester exhaust system regularly to make sure it is maintained and working properly. Use the procedure in the Operation & Maintenance Manual for cleaning the spark arrester muffler (if equipped).

## Welding And Grinding

Always clean the machine and implement, disconnect the battery, and disconnect the wiring from the Ignite Attachments controllers before welding. Cover rubber hoses, battery, and all other flammable parts. Keep a fire extinguisher near the machine when welding.

Have good ventilation when grinding or welding painted parts. Wear a dust mask when grinding painted parts. Toxic dust or gas can be produced.

Dust generated from repairing nonmetallic parts such as hoods, fenders, or covers can be flammable or explosive. Repair such components in a well-ventilated area away from open flames or sparks.

## Fire Extinguishers

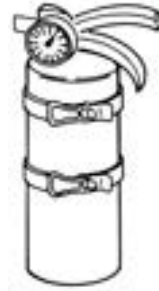

Know where fire extinguishers and first aid kits are located and how to use them. Inspect the fire extinguisher and service the fire extinguisher regularly. Obey the recommendations on the instructions plate.

## PUBLICATIONS AND TRAINING RESOURCES

The following publications are also available for your Ignite implement. You can order from the Ignite attachments website.

For the latest information on Ignite products and the Ignite attachments, visit our website at [igniteattachments.com](http://igniteattachments.com)



### OPERATION & MAINTENANCE MANUAL

7496662enUS

Complete instructions on the correct operation and the routine maintenance of the Ignite implement.



### ADMA SAFETY MANUAL

6904759



### AEM SAFETY MANUAL

6900582

## ATTACHMENT SIGNS (DECALS)

Follow the instructions on all the Attachment Signs (Decals) that are on the attachment. Replace any damaged attachment signs and be sure they are in the correct locations. Attachment signs are available from your Ignite Attachments representative.

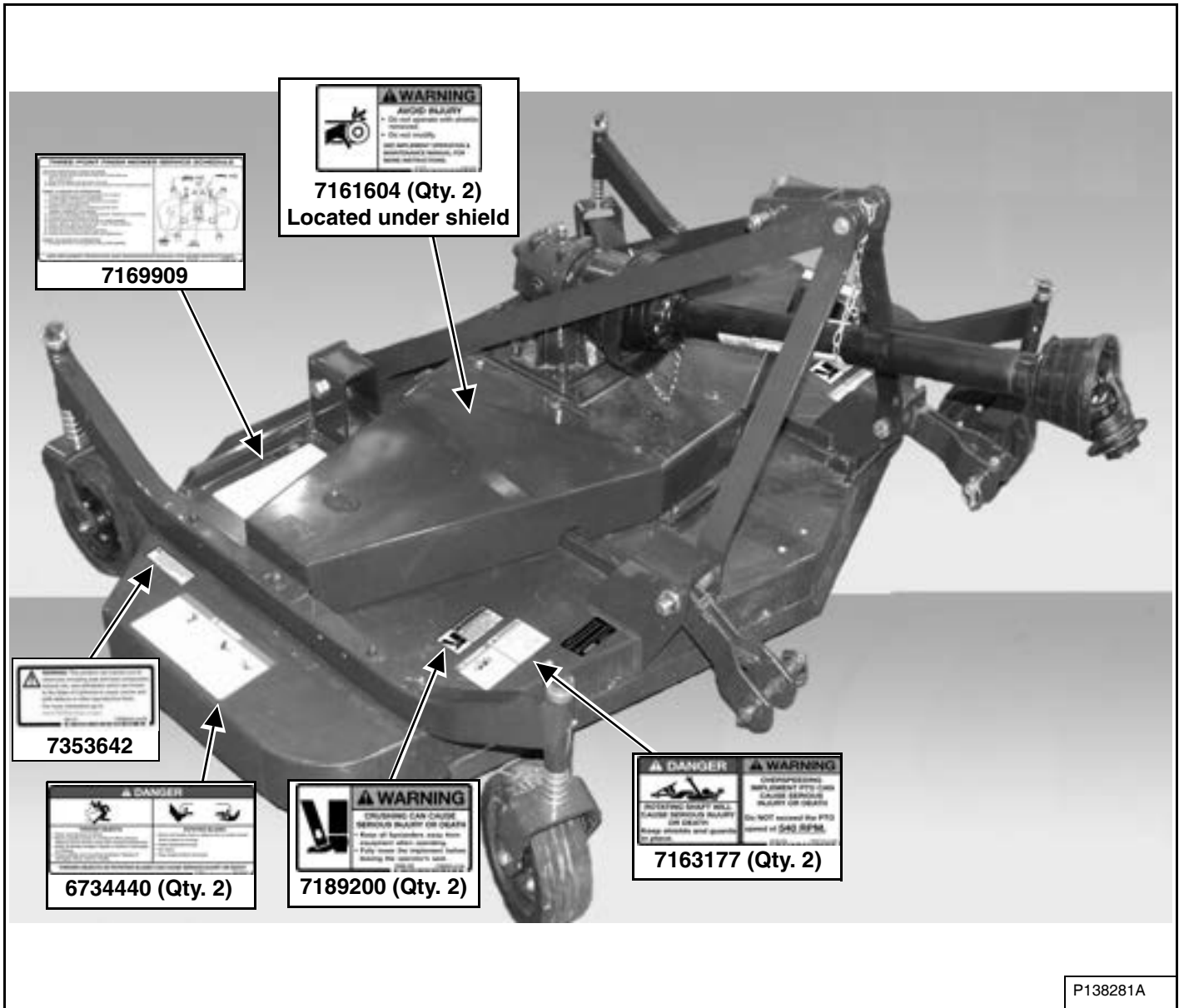

## OPERATING INSTRUCTIONS

ASSEMBLING THE THREE-POINT FINISH MOWER .....	19
Castor Wheel Installation .....	19
Three-Point Installation .....	20
Gearbox Shield Installation .....	20
Gearbox Oil Plug / Breather Valve .....	21
Gearbox Oil Check .....	21
DAILY INSPECTION .....	22
Implement Mounting Frame .....	22
Three-Point Hitch .....	22
OPERATING PROCEDURE WITH COMPACT TRACTOR .....	23
Approved Compact Tractor Models & Requirements .....	23
Compact Tractor / Implement Setup .....	23
Setting Up The Ballast .....	23
Entering And Exiting The Compact Tractor .....	23
Installation .....	24
Rear Power Take-Off (PTO) .....	28
Control Functions Three-Point Hitch .....	34
Control Functions Rear-PTO .....	34
Operation With The Compact Tractor .....	36
Removal .....	39
LIFTING THE IMPLEMENT .....	41
Procedure .....	41
TRANSPORTING THE IMPLEMENT ON A TRAILER .....	41
Fastening .....	41
TRANSPORTING THE IMPLEMENT AND MACHINE ON A TRAILER .....	42
Loading And Fastening .....	42



## ASSEMBLING THE THREE-POINT FINISH MOWER

### Castor Wheel Installation

# WARNING

Flying debris or pressurized fluids can cause serious injury or death.

Wear safety glasses to prevent eye injury when any of the following conditions exist:

- When fluids are under pressure.
- Flying debris or loose material.
- Engine is running.
- Tools are being used.

Figure 2

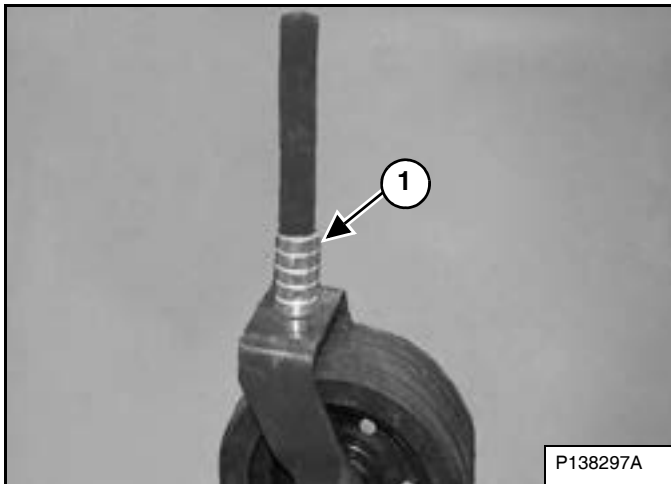

Add spacers (Item 1) [Figure 2] in 13 mm (.50 in) increments to achieve the required cutting height.

**NOTE: All castor wheels must be adjusted the same for correct mower operation.**

Figure 3

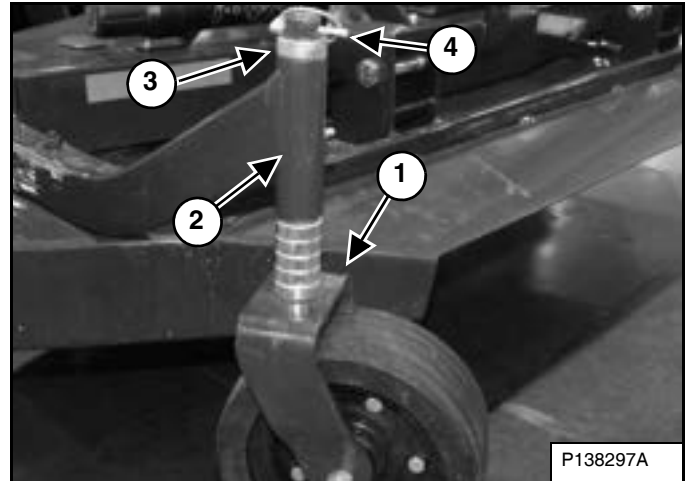

Install the wheel fork (Item 1) through the wheel mounting bushing (Item 2). Place remaining spacers (Item 3) onto the wheel fork and install the retaining pin (Item 4) [Figure 3].

Repeat the procedure for the remaining wheels.

## ASSEMBLING THE THREE-POINT FINISH MOWER (CONT D)

### Three-Point Installation

Figure 4

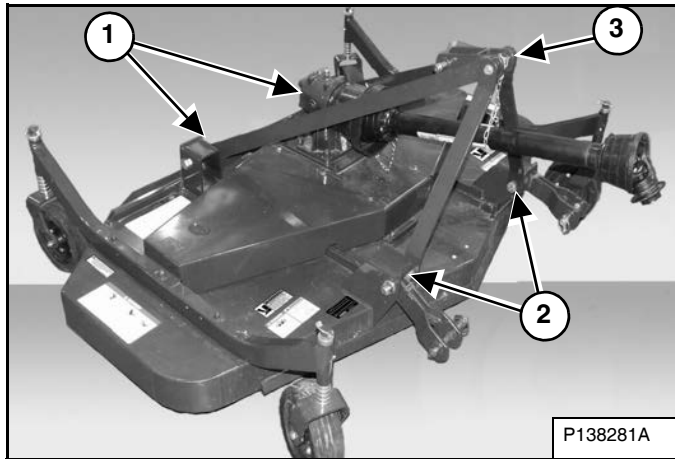

**NOTE:** Do not fully tighten retaining hardware at this time.

Position the longer shafts (Item 1) [Figure 4] with the rear supports. Align mounting holes and install the M20x130 bolts, washers, and nuts.

Position the shorter shafts (Item 2) [Figure 4] with the front supports. Align mounting holes and install the M20x130 bolts, spacers, washers, and nuts.

Position and align the upper link (Item 3) [Figure 3] mounting holes with the rear and front shaft holes and install the M12x130 bolt, washer, spacer, washer, and nut.

Tighten the mounting hardware to 91 N•m (67 ft-lb) of torque.

Figure 5

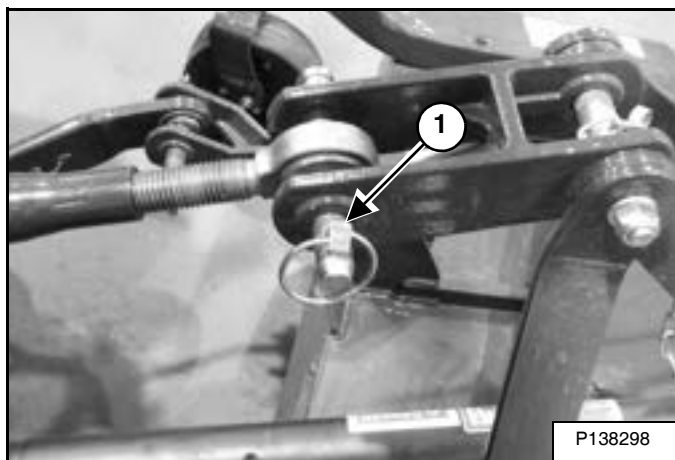

Install the upper three-point pin and retaining pin (Item 1) [Figure 5].

Figure 6

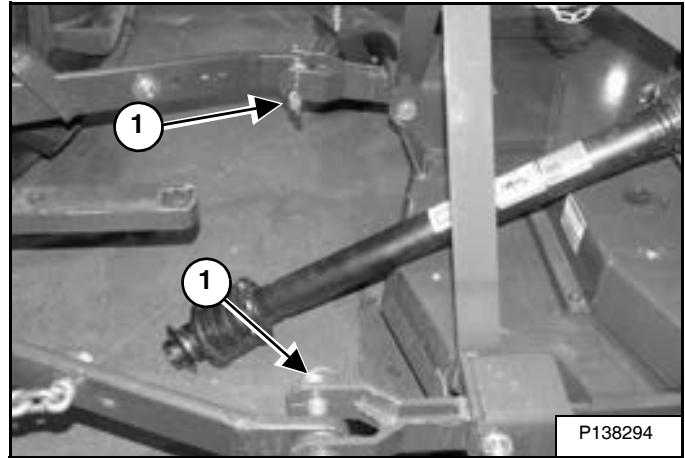

Install the lower three-point pins and retaining pins (Item 1) [Figure 6].

### Gearbox Shield Installation

Figure 7

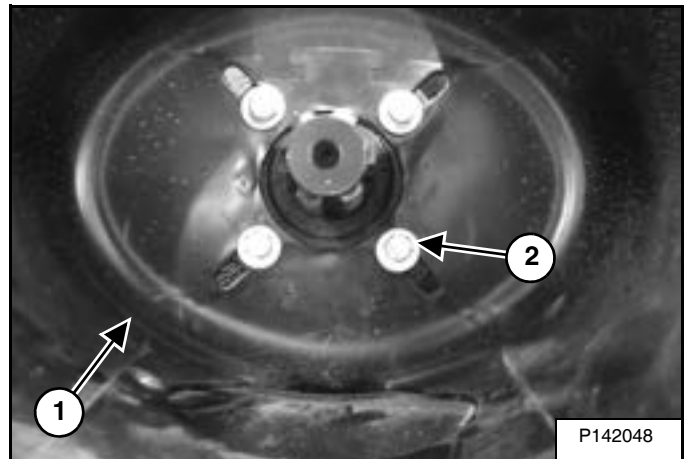

Install the gearbox shield (Item 1) onto gearbox. Fasten with four M8x16 bolts (Item 2) [Figure 7] and washers loosely. Center the PTO guard on the shaft, tighten the four bolts to 24 N•m (18 ft-lb) of torque.

## ASSEMBLING THE THREE-POINT FINISH MOWER (CONT D)

### Gearbox Oil Plug / Breather Valve

Figure 8

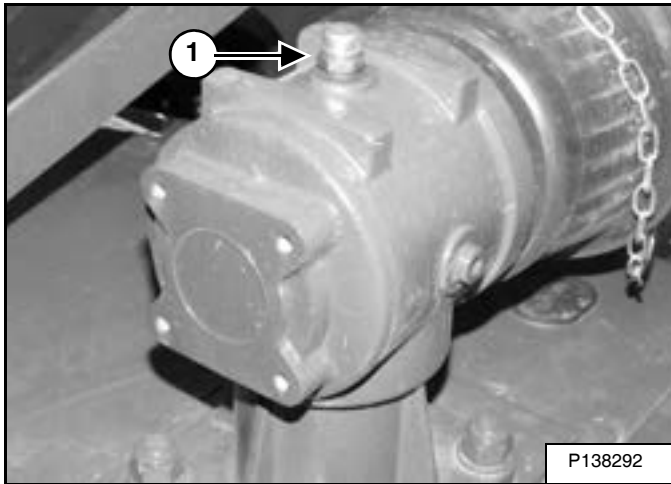

Replace the plug on the upper part of the gearbox with the vented plug (Item 1) **[Figure 8]** supplied with the finish mower. Be careful not to over tighten, as this could warp the sheath and cause an oil leak.

### Gearbox Oil Check

Figure 9

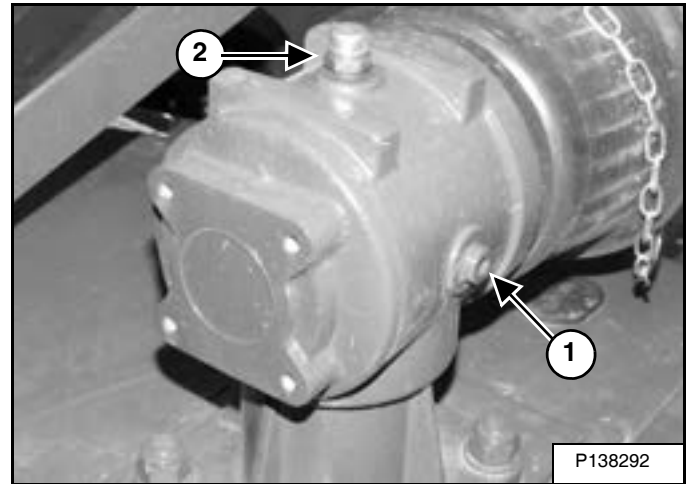

Check the oil in the gearbox by unscrewing the side plug (Item 1) **[Figure 9]** and check that the oil level is at the lower edge of the hole.

If necessary, remove the top vented plug (Item 2) **[Figure 9]** and add oil until the oil level is at the lower edge of the side plug hole.

Reinstall the side plug and top vented plug.

The finish mower assembly is complete and ready to operate.

## DAILY INSPECTION

### Implement Mounting Frame

Figure 10

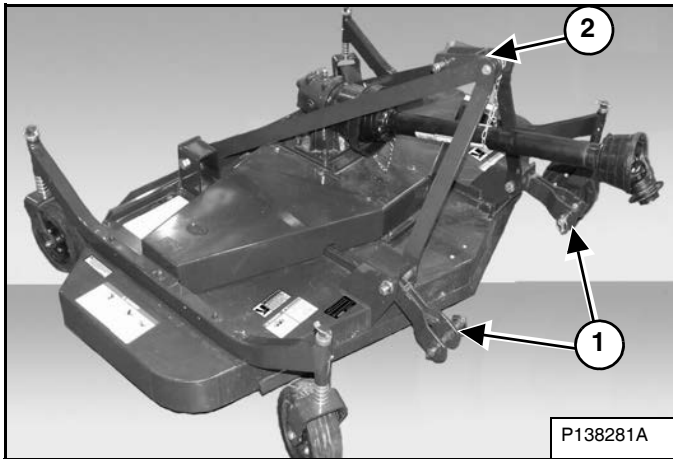

Inspect the lower three-point mounts and lower mounting pins (Item 1) and upper three-point mount and pin (Item 2) [Figure 10], along with all welds on the three-point mower for wear and damage each time the three-point mower is removed from the compact tractor.

Check the following items at the start of a work day:

- Check for damaged or missing decals. Replace if necessary.
- Replace any worn or damaged parts immediately.

### Three-Point Hitch

**! WARNING**

#### AVOID INJURY OR DEATH

The parking brake must be engaged before leaving the operator's seat. Rollaway can occur because the transmission may not prevent machine movement. Lock the brake pedals together (if equipped) before activating the parking brake.

W-2656-0719

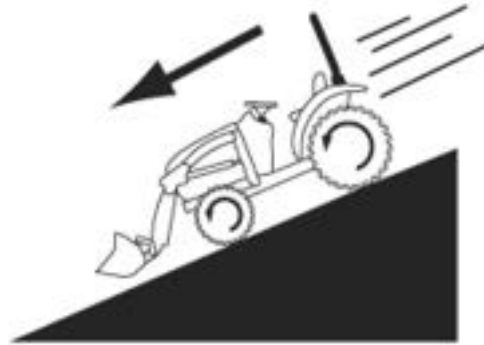
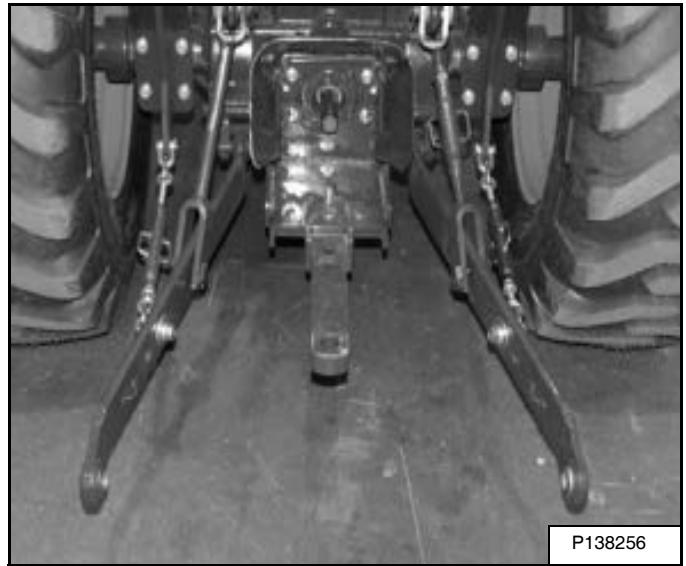

Figure 11



Inspect the three-point hitch linkage, PTO shaft splines, guards, and shields. Replace if damaged or missing [Figure 11]. Repair broken or loose parts.

See your machine Operation & Maintenance Manual for detailed information on inspecting the three-point hitch.

## OPERATING PROCEDURE WITH COMPACT TRACTOR

### Approved Compact Tractor Models & Requirements

Figure 12

	FM60	FM72
TRACTOR PTO HP	23-40	32-40

The chart [Figure 12] shows the approved finish mowers for compact tractors based on horsepower.

The compact tractor must be equipped with category I or II three point hitch and have a Power Take Off (PTO) rated for 540 rpm and with a 6-spline, 1-3/8" diameter output shaft.

**NOTE: The three-point finish mower is not compatible for use with a three-point Quick Hitch.**

**Warranty on this implement is void if used on a non-approved carrier. Contact your Ignite Attachments representative for a current list of approved carriers.**

## WARNING

**Use of unapproved attachments, implements or improperly sized attachments can cause serious injury or death.**

**Attachments, implements and buckets for safe loads of specified densities are approved for each model. Never use attachments, implements or buckets which are not approved by Ignite Attachments.**

### Compact Tractor / Implement Setup

#### *Setting Up The Ballast*

Install the correct ballast on the compact tractor before installing the implement. See the compact tractor Operation & Maintenance Manual for ballast information.

### Entering And Exiting The Compact Tractor

## WARNING

**Failure to follow instructions can cause serious injury or death.**

**Use ROPS and fasten the seat belt.**

**Install the correct ballast (if required).**

**Never modify equipment. Never use unapproved implements or attachments.**

**Operate the compact tractor from the operator's seat only.**

**Keep bystanders away. Never carry riders.**

---

See your compact tractor Operation & Maintenance Manual for detailed information on entering and exiting the compact tractor.

Make sure the PTO driveline and all rotating components have come to a complete stop before exiting the compact tractor (if applicable).

## WARNING

### AVOID INJURY OR DEATH

**Before you leave the operator's seat:**

**Fully lower the loader arms, put the attachment flat on the ground (if equipped).**

**Fully lower the implement(s) to the ground (if equipped).**

**Lock brake pedals together (if equipped) and engage the parking brake.**

**Place all controls in neutral.**

**Stop the engine, unfasten the seat belt and remove the key.**

---

## OPERATING PROCEDURE WITH COMPACT TRACTOR (CONT D)

### Installation

#### Three-Point Implement

**NOTE:** The illustrations and instructions provided explain how to install a three-point mower on to a compact tractor. Follow these same instructions if you are installing different three-point implements such as a rake tine, angle blade, box blade, etc.

Always inspect the compact tractor's three-point hitch and implement three-point mounting frame before installation. See the compact tractor Operation & Maintenance Manual. (See DAILY INSPECTION on Page 22.)

## **WARNING**

Warnings on the machine and in the manuals are for your safety. Failure to obey warnings can cause serious injury or death.

W-2744-0608

**Figure 13**

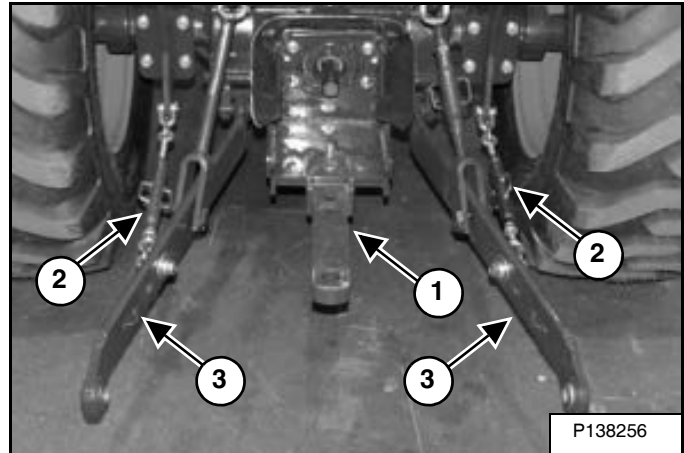

Move the drawbar (Item 1) [Figure 13] to the storage position or remove (if necessary). See the compact tractor Operation & Maintenance Manual for detailed information.

The three-point hitch lower links must be set wide enough to clear the implement mounting pins.

Adjust the sway bars (Item 2) (both sides) and move the lower links (Item 3) [Figure 13] as needed. (See Sway Bar Adjustment on Page 27.)

## OPERATING PROCEDURE WITH COMPACT TRACTOR (CONT D)

### Installation (Cont d)

#### Three-Point Implement (Cont'd)

## WARNING

### AVOID INJURY OR DEATH

Before backing the compact tractor, look in all directions and make sure no bystanders are in the work area. Do not allow anyone between the compact tractor and the implement when backing up to the implement for installation.

W-2570-0807

Enter the compact tractor. (See Entering And Exiting The Compact Tractor on Page 23.) Start the engine and release the parking brake.

Figure 14

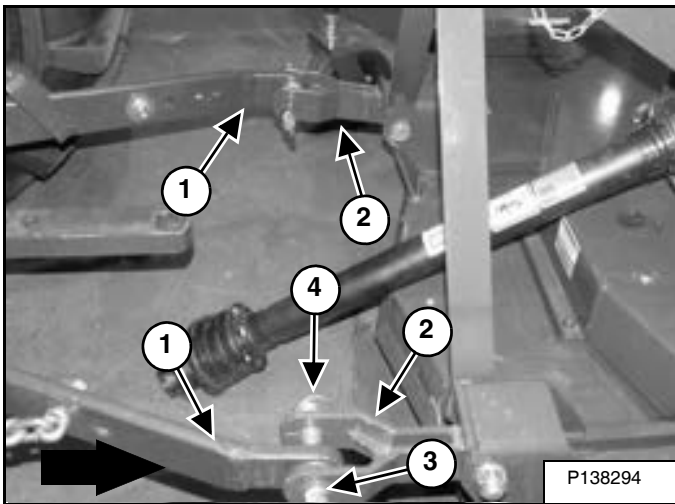

Drive the compact tractor to the implement and align the lower links (Item 1) with the implement mounting pins (Item 2) [Figure 14] (both sides).

Lower or raise the compact tractor's three-point hitch lower links (Item 1) until they are even with the mounting pins (Item 2) [Figure 14] (both sides) of the three-point implement. (See the compact tractor Operation & Maintenance Manual for detailed information on operating the compact tractor.)

Stop the engine and exit the compact tractor. (See Entering And Exiting The Compact Tractor on Page 23.)

Install the implement mounting pins (Item 3) and the retainer pins (Item 4) [Figure 14] (both sides).

## WARNING

### CRUSHING CAN CAUSE SERIOUS INJURY OR DEATH

Keep arms and feet away from attachment / implement while raising and lowering.

Do Not stand between the compact tractor and attachment / implement.

Move the three-point hitch position lever slowly.

W-2748-0123

## WARNING

### AVOID INJURY OR DEATH

Keep fingers and hands out of pinch points when installing and removing implement or attachment.

W-2571-1212

## OPERATING PROCEDURE WITH COMPACT TRACTOR (CONT D)

### Installation (Cont d)

#### Three-Point Implement (Cont'd)

**Figure 15**

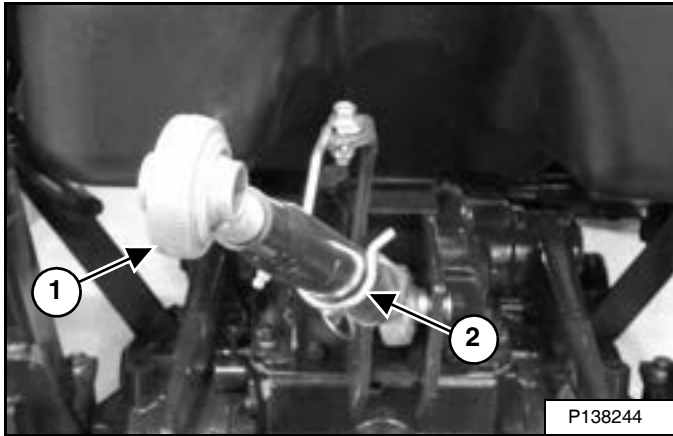

Remove the top link (Item 1) from the storage position bracket (Item 2) [Figure 15].

**Figure 16**

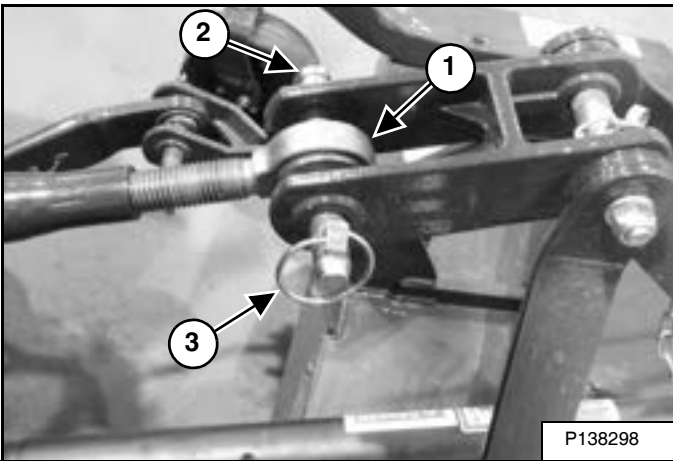

Lower the top link (Item 1) [Figure 16] until it aligns with the implement upper mounting hole.

Install the pin (Item 2) and retainer pin (Item 3) [Figure 16].

**NOTE:** It may be necessary to lengthen or shorten the top link to align it with the implement mounting hole [Figure 16]. (See Top Link Adjustment on Page 26.)

The implement can be leveled front to back by adjusting the top link. (See Top Link Adjustment on Page 26.)

The implement side to side sway will need to be adjusted. (See Sway Bar Adjustment on Page 27.)

### Lift Link Adjustment

**Figure 17**

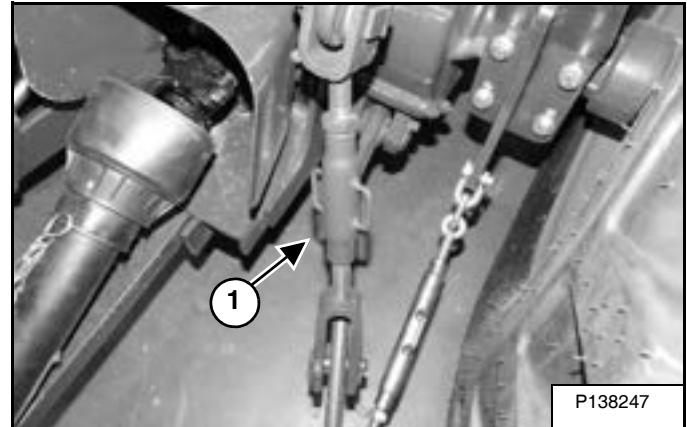

The right lift link (Item 1) [Figure 17] is used to adjust the side to side level of the implement.

See the compact tractor Operation & Maintenance Manual for detailed information on adjusting the lift link.

### Top Link Adjustment

**Figure 18**

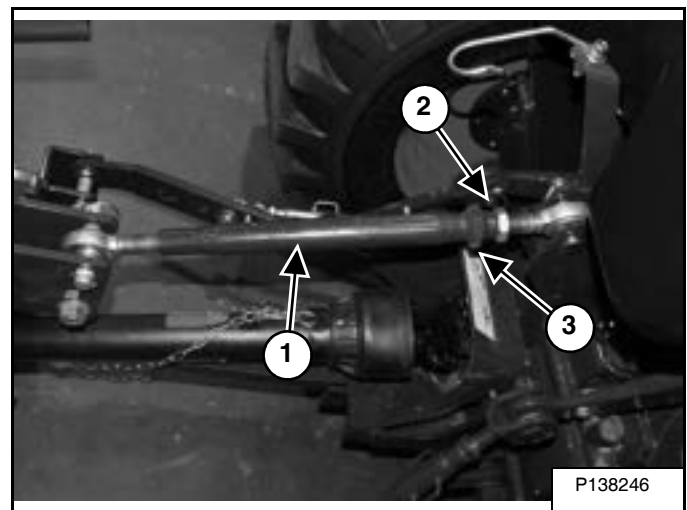

The top link (Item 1) [Figure 18] is used to adjust the front to back level of the implement.

Loosen the lock nut (Item 2) and use the adjuster (Item 3) [Figure 18] to lengthen or shorten the top link.

Turn clockwise to lengthen the top link, turn counter-clockwise to shorten top link.

After the implement has been leveled, tighten the lock nut (Item 2) [Figure 18].

## OPERATING PROCEDURE WITH COMPACT TRACTOR (CONT D)

### Installation (Cont d)

#### *Sway Bar Adjustment*

**Figure 19**

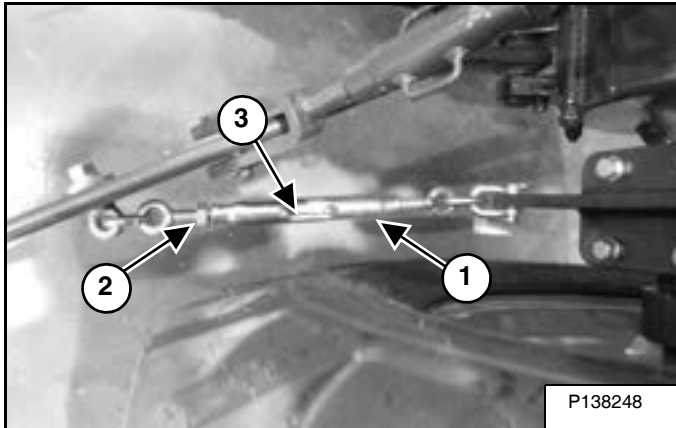

The sway bars (Item 1) [Figure 19] (both sides) are used to center the implement between the tires and limits the implements side to side movement

Loosen the lock nut (Item 2) from both sway bars and use the lever (Item 3) [Figure 19] to lengthen or shorten the sway bar.

Adjust the sway bars to center the implement between the tires.

After the implement has been centered, tighten the lock nut (Item 2) [Figure 19].

**NOTE: When adjusting the sway bars with the implement installed, the implement will need to be raised slightly off of the ground.**

## OPERATING PROCEDURE WITH COMPACT TRACTOR (CONT D)

### Rear Power Take-Off (PTO)

#### Installation

The compact tractor must be equipped with a rear-PTO that has a **540 RPM** PTO shaft.

Install the implement to the compact tractor. (See Installation on Page 24.)

## WARNING

Warnings on the machine and in the manuals are for your safety. Failure to obey warnings can cause serious injury or death.

W-2744-0608

Stop the engine and exit the compact tractor. (See Entering And Exiting The Compact Tractor on Page 23.)

Make sure the PTO driveline and all rotating components have come to a complete stop before exiting the compact tractor (if applicable).

Figure 20

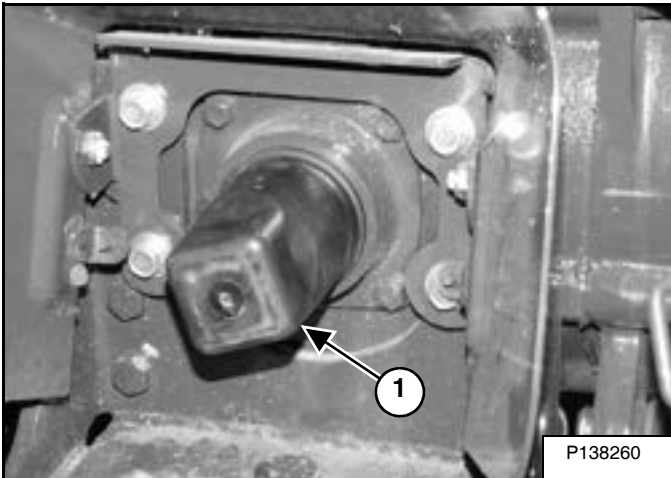

Remove the PTO shaft cover (Item 1) [Figure 20]. (See the compact tractor Operation & Maintenance Manual for detailed information.)

**NOTE: Reinstall the PTO shaft cover whenever the PTO is not being used.**

Remove the PTO driveline from the implement storage position.

## IMPORTANT

Improper hitch installation can cause PTO driveline damage.

Do not modify the hitch or use an unapproved hitch.

Make sure PTO driveline is of adequate length and that u-joints are in the correct phase.

I-2249-0807

## WARNING

### AVOID INJURY OR DEATH

Do NOT exceed the rated implement / attachment PTO speed.

Stay clear of rotating driveline.

Keep bystanders away.

Keep hands, feet, clothing and long hair away.

Keep PTO shields and all guards in place.

Disengage PTO (rear and mid), engage the parking brake, stop the engine and make sure all rotating components are stopped before exiting compact tractor.

Do NOT service the compact tractor or implement / attachment with the PTO (rear or mid) engaged.

Do NOT service the implement / attachment in a raised position unless properly blocked and with all rotating components stopped.

Disengage PTO (rear and mid) for road travel.

W-2697-1212

## OPERATING PROCEDURE WITH COMPACT TRACTOR (CONT D)

### Rear Power Take-Off (PTO) (Cont d)

*Installation (Cont'd)*

**Figure 21**

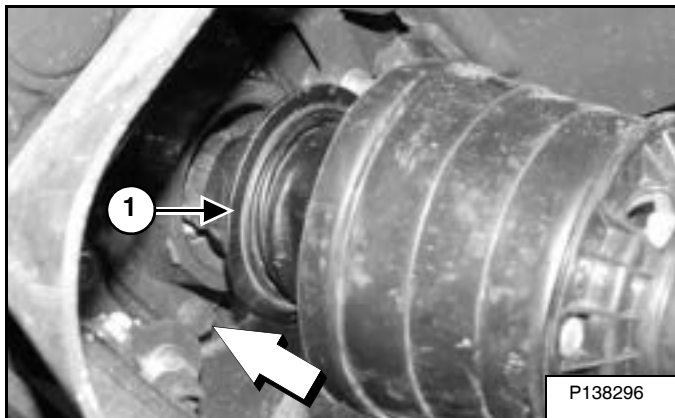

Use the correct PTO driveline for use with the compact tractor rear-PTO shaft and the implement PTO shaft.

Retract the collar (Item 1) [Figure 21] and slide the PTO driveline onto the compact tractor rear-PTO shaft. Release the collar and the driveline will lock onto the shaft. Push and pull the PTO driveline back and forth several times and make sure it is securely attached to the PTO shaft.

**NOTE: The rear-PTO driveline must have a means to retain it to the PTO shaft on both the compact tractor and the implement.**

## **WARNING**

### **AVOID INJURY OR DEATH**

**Keep PTO shields and all guards in place.**

**Keep away from moving parts.**

**Keep bystanders away.**

**Do NOT exceed 540 rear-PTO RPM or 2000 mid-PTO RPM.**

W-2659-0907



## OPERATING PROCEDURE WITH COMPACT TRACTOR (CONT D)

### Rear Power Take-Off (PTO) (Cont d)

#### Removal

Always park on flat level ground. Fully lower the lift arm and put the implement flat on the ground (if equipped).

Stop the engine and exit the compact tractor. (See Entering And Exiting The Compact Tractor on Page 23.)

Make sure the PTO driveline and all rotating components have come to a complete stop before exiting the compact tractor (if applicable).

## **WARNING**

### AVOID INJURY OR DEATH

Before you leave the operator's seat:

**Fully lower the loader arms, put the attachment flat on the ground (if equipped).**

**Fully lower the implement(s) to the ground (if equipped).**

**Lock brake pedals together (if equipped) and engage the parking brake.**

**Place all controls in neutral.**

**Stop the engine, unfasten the seat belt and remove the key.**

Figure 22

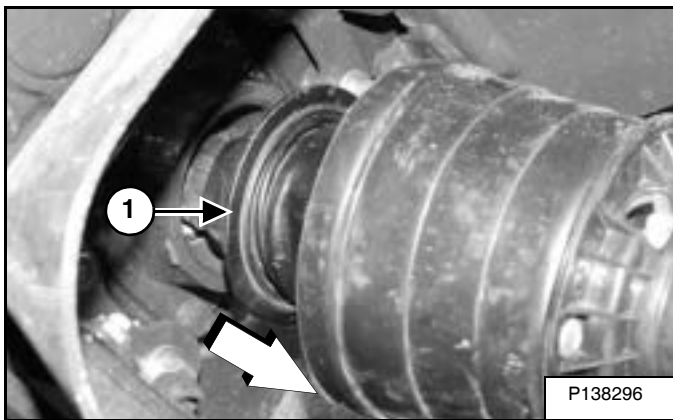

Retract the collar (Item 1) [Figure 22] and pull the PTO driveline off the compact tractor rear-PTO shaft.

Remove the implement from the compact tractor. (See Removal on Page 39.)

Place the PTO driveline into the implement storage position (if applicable).

Figure 23

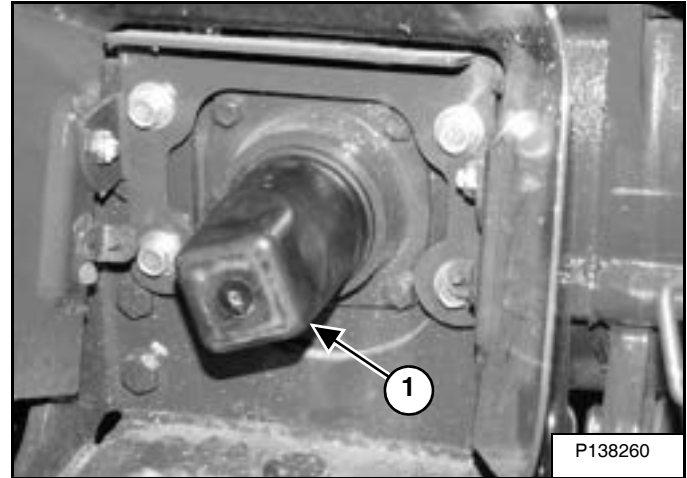

Install the PTO shaft cover (Item 1) [Figure 23]. (See the compact tractor Operation & Maintenance Manual for detailed information.)

## **WARNING**

### AVOID INJURY OR DEATH

**Do NOT exceed the rated implement / attachment PTO speed.**

**Stay clear of rotating driveline.**

**Keep bystanders away.**

**Keep hands, feet, clothing and long hair away.**

**Keep PTO shields and all guards in place.**

**Disengage PTO (rear and mid), engage the parking brake, stop the engine and make sure all rotating components are stopped before exiting compact tractor.**

**Do NOT service the compact tractor or implement / attachment with the PTO (rear or mid) engaged.**

**Do NOT service the implement / attachment in a raised position unless properly blocked and with all rotating components stopped.**

**Disengage PTO (rear and mid) for road travel.**

W-2697-1212

## OPERATING PROCEDURE WITH COMPACT TRACTOR (CONT D)

### Rear Power Take-Off (PTO) (Cont d)

#### PTO Driveline Length Check

**NOTE:** Due to variations in distances between tractor PTO shafts and implement input shafts, drivelines may need to be shortened or a longer shaft may be required. When fitting the implement to the compact tractor, the PTO driveline, with telescoping sections, must be inspected. When the sections are at the most compressed operating position, the sections must not bottom out. At its shortest length, there must be at least 2 in. (50,8 mm) of clearance between each section end and opposite section end at the most compressed operating position. When the sections are at the most extended position, there must be sufficient engagement between the sections. At its farthest operating extension, a minimum section engagement of 33% of shaft length must be maintained. (See PTO Driveline Engagement Check on Page 33.)

#### PTO Driveline Bottoming Out Check Procedure

Stop the engine and exit the compact tractor. (See Entering And Exiting The Compact Tractor on Page 23.)

Make sure the PTO driveline and all rotating components have come to a complete stop before exiting the compact tractor (if applicable).

## **WARNING**

### **AVOID INJURY OR DEATH**

**Do NOT** exceed the rated implement / attachment PTO speed.

**Stay clear** of rotating driveline.

**Keep bystanders** away.

**Keep hands, feet, clothing and long hair** away.

**Keep PTO shields and all guards** in place.

**Disengage PTO (rear and mid), engage the parking brake, stop the engine and make sure all rotating components are stopped before exiting compact tractor.**

**Do NOT** service the compact tractor or implement / attachment with the PTO (rear or mid) engaged.

**Do NOT** service the implement / attachment in a raised position unless properly blocked and with all rotating components stopped.

**Disengage PTO (rear and mid) for road travel.**

W-2697-1212

Figure 24

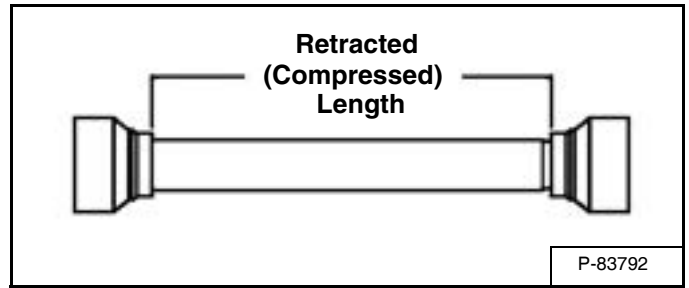

1. Disconnect the PTO driveline from the compact tractor and slide the PTO driveline together until fully retracted.
2. Measure the retracted length of PTO driveline [Figure 24].

Figure 25

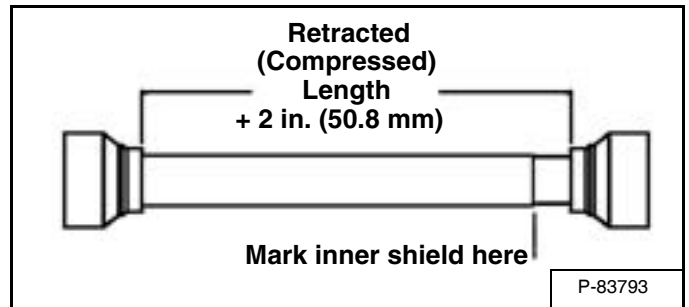

3. Extend the PTO driveline 2 in. (50.8 mm) from the retracted length and make a mark at the end of the outer shield on the inner shield [Figure 25].
4. Reattach the PTO driveline to the compact tractor PTO shaft.
5. Enter the compact tractor. (See Entering And Exiting The Compact Tractor on Page 23.) Start the engine.
6. With the rear PTO **DISENGAGED**, raise and lower the implement and watch the PTO driveline expand and retract.
7. If the outer PTO driveline plastic guard slides in (retracts) over the mark at any point of travel, the PTO driveline needs to be shortened.

## OPERATING PROCEDURE WITH COMPACT TRACTOR (CONT D)

### Rear Power Take-Off (PTO) (Cont d)

#### *Reducing The Length Of The PTO Driveline*

Stop the engine and exit the compact tractor. (See Entering And Exiting The Compact Tractor on Page 23.)

Make sure the PTO driveline and all rotating components have come to a complete stop before exiting the compact tractor.

## **WARNING**

### **AVOID INJURY OR DEATH**

**Do NOT** exceed the rated implement / attachment PTO speed.

**Stay clear of rotating driveline.**

**Keep bystanders away.**

**Keep hands, feet, clothing and long hair away.**

**Keep PTO shields and all guards in place.**

**Disengage PTO (rear and mid), engage the parking brake, stop the engine and make sure all rotating components are stopped before exiting compact tractor.**

**Do NOT** service the compact tractor or implement / attachment with the PTO (rear or mid) engaged.

**Do NOT** service the implement / attachment in a raised position unless properly blocked and with all rotating components stopped.

**Disengage PTO (rear and mid) for road travel.**

W-2697-1212

Remove the PTO driveline from the compact tractor and place in storage position (if equipped). (See Removal on Page 30.)

Enter the compact tractor. (See Entering And Exiting The Compact Tractor on Page 23.)

Start the engine and release the parking brake.

Raise or lower the three-point implement to get the shortest distance between the compact tractor PTO shaft and three-point implement gearbox PTO shaft.

Stop the engine and exit the compact tractor. (See Entering And Exiting The Compact Tractor on Page 23.)

Pull the PTO driveline apart and reinstall each individual section; one half to the compact tractor PTO shaft and one half to the implement gearbox PTO shaft.

Figure 26

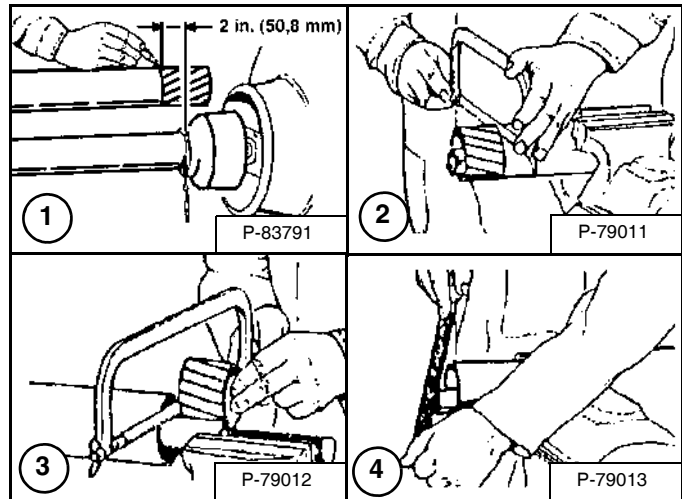

1. Hold PTO driveline sections parallel to one another and measure back 2 in. (50.8 mm) (Item 1) from the yoke of each section and place mark on opposite section. Cut the plastic shield at this length (Item 2) [Figure 26].
2. Use the plastic shield length that was just cut and align it with the end of the inner shaft (Item 3) [Figure 26]. Cutting the same amount off the end of the inner shaft.
3. Round off all sharp edges and debur (Item 4) [Figure 26].
4. Repeat steps 1-3 for the other shaft section. Equal amounts must be cut from each shaft.
5. Thoroughly grease and install the PTO driveline halves together.
6. Recheck for proper operation.

## **WARNING**

### **AVOID INJURY OR DEATH**

**Keep PTO shields and all guards in place.**

**Keep away from moving parts.**

**Keep bystanders away.**

**Do NOT** exceed 540 rear-PTO RPM or 2000 mid-PTO RPM.

W-2659-0907



## OPERATING PROCEDURE WITH COMPACT TRACTOR (CONT D)

### Rear Power Take-Off (PTO) (Cont d)

#### PTO Driveline Engagement Check

Exit the compact tractor. (See Entering And Exiting The Compact Tractor on Page 23.)

Make sure the PTO driveline and all rotating components have come to a complete stop before exiting the compact tractor.



#### AVOID INJURY OR DEATH

Do NOT exceed the rated implement / attachment PTO speed.

Stay clear of rotating driveline.

Keep bystanders away.

Keep hands, feet, clothing and long hair away.

Keep PTO shields and all guards in place.

Disengage PTO (rear and mid), engage the parking brake, stop the engine and make sure all rotating components are stopped before exiting compact tractor.

Do NOT service the compact tractor or implement / attachment with the PTO (rear or mid) engaged.

Do NOT service the implement / attachment in a raised position unless properly blocked and with all rotating components stopped.

Disengage PTO (rear and mid) for road travel.

W-2697-1212

1. Disconnect the PTO driveline from the compact tractor and slide the driveline sections together until fully retracted.

Figure 27

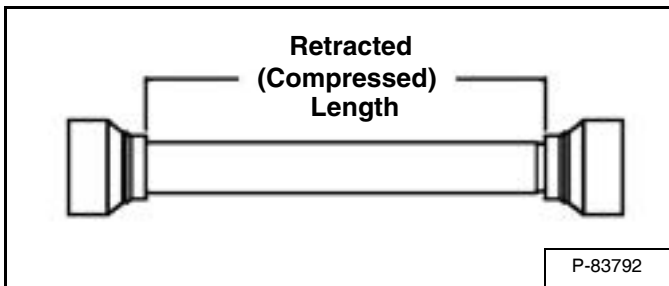

2. Measure the retracted (compressed) length of the PTO driveline between the bases of the plastic shields [Figure 27].
3. Multiply the retracted driveline length by 1.667 to determine the PTO driveline Maximum Operating Length. (i.e.: 25.5 in. (647,7 mm) x 1.667 = 42.5 in. (1079,7 mm) Maximum Operating Length).

4. Attach the PTO driveline to the compact tractor PTO output shaft.
5. Enter the compact tractor. (See Entering And Exiting The Compact Tractor on Page 23.)

Figure 28

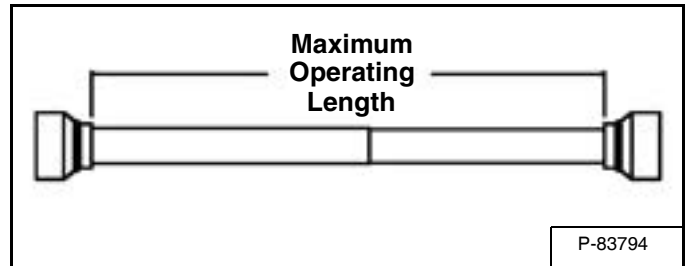

6. With the PTO driveline attached, position the three-point implement to where the telescoping PTO driveline is at its maximum operating extension.
7. Exit the compact tractor. (See Entering And Exiting The Compact Tractor on Page 23.) Make sure the PTO driveline and all rotating components have come to a complete stop before exiting the compact tractor.
8. Measure the length of the PTO driveline between the bases of the plastic shields [Figure 28] to determine the maximum operating length.

A. If the measured maximum operating length is less than the Maximum Operating Length calculation (from Step 3), the PTO driveline has adequate engagement

B. If the measured maximum operating length is equal to or more than the Maximum Operating Length calculation (from Step 3), the PTO driveline does not have adequate engagement and should be replaced with a longer driveline. Contact your Ignite Attachments representative for available PTO drivelines.

## OPERATING PROCEDURE WITH COMPACT TRACTOR (CONT D)

### Control Functions Three-Point Hitch

The three-point hitch will be used to raise or lower the implement. (See the compact tractor Operation & Maintenance Manual for detailed information on operating the three-point hitch).

### Control Functions Rear-PTO

#### *Safety Rules For PTO Operation*

## **WARNING**

### **AVOID INJURY OR DEATH**

**Do NOT exceed the rated implement / attachment PTO speed.**

**Stay clear of rotating driveline.**

**Keep bystanders away.**

**Keep hands, feet, clothing and long hair away.**

**Keep PTO shields and all guards in place.**

**Disengage PTO (rear and mid), engage the parking brake, stop the engine and make sure all rotating components are stopped before exiting compact tractor.**

**Do NOT service the compact tractor or implement / attachment with the PTO (rear or mid) engaged.**

**Do NOT service the implement / attachment in a raised position unless properly blocked and with all rotating components stopped.**

**Disengage PTO (rear and mid) for road travel.**

W-2697-1212

## **WARNING**

**Warnings on the machine and in the manuals are for your safety. Failure to obey warnings can cause serious injury or death.**

W-2744-0608

## **WARNING**

### **AVOID INJURY OR DEATH**

**Before you leave the operator s seat:**

**Fully lower the loader arms, put the attachment flat on the ground (if equipped).**

**Fully lower the implement(s) to the ground (if equipped).**

**Lock brake pedals together (if equipped) and engage the parking brake.**

**Place all controls in neutral.**

**Stop the engine, unfasten the seat belt and remove the key.**

- 
- Keep all shields in place. Replace damaged or missing shields before operating
  - Follow warnings and instructions on machine signs (decals). Replace damaged or missing decals.
  - Do not wear loose or bulky clothing around the PTO or other moving parts.
  - Keep bystanders away from PTO driven equipment, and never allow children near machines.
  - Read and understand the manuals for the PTO driven equipment and be aware of safe operating procedures and hazards that may not be readily apparent.
  - Always walk around equipment to avoid coming near a turning PTO driveline. Stepping over, leaning across or crawling under a turning PTO driveline can lead to entanglement.
  - Never overspeed the PTO. See implement Operation & Maintenance Manual for correct PTO speed.
  - Position the machine and implement hitch correctly to prevent driveline stress and separation.
  - Use caution when turning. Turning too sharp can cause driveline damage.

## OPERATING PROCEDURE WITH COMPACT TRACTOR (CONT D)

### Control Functions Rear-PTO (Cont d)

#### *Engaging The Rear-PTO*

Enter the compact tractor. (See Entering And Exiting The Compact Tractor on Page 23.)

Start the engine and release the parking brake.

Lower the implement to the ground. (See the compact tractor Operation & Maintenance Manual for detailed information on operating the compact tractor.)

Move the engine speed control lever to low engine speed.

## IMPORTANT

**To avoid start-up overload on PTO driveline, reduce engine speed to low idle when engaging the PTO. After PTO driveline is rotating, increase engine speed.**

I-2272-0812

Engage the rear-PTO system (see the compact tractor Operation & Maintenance Manual).

The rear-PTO driveline will start to rotate.

Move the engine speed lever to increase engine speed to the correct RPM as indicated on the tachometer. This will cause the rear-PTO shaft to rotate at 540 RPM. Do Not exceed a rear-PTO speed of 540 RPM.



## WARNING

### AVOID INJURY OR DEATH

**Keep PTO shields and all guards in place.**

**Keep away from moving parts.**

**Keep bystanders away.**

**Do NOT exceed 540 rear-PTO RPM or 2000 mid-PTO RPM.**

W-2659-0907



#### *Disengaging The Rear-PTO*

Move the engine speed lever back to the low idle position.

Disengage the rear-PTO system. (See the compact tractor Operation & Maintenance Manual.)

## OPERATING PROCEDURE WITH COMPACT TRACTOR (CONT D)

### Operation With The Compact Tractor

#### *Driving The Implement And Tractor To Worksite*

Read and understand the implement Operation & Maintenance Manual and the compact tractor Operation & Maintenance Manual prior to installing or using any implement.

## **WARNING**

### **AVOID INJURY OR DEATH**

Steering and braking can be affected by the loader attachment, implements, front wheel assist and the rear differential lock. Always install the correct ballast. Do not exceed the Loader or Three-Point Hitch lift capacities.

Always carry loads low. Slow down when turning. Always lock the brake pedals together (if equipped) for road travel.

Unlock the brake pedals (if equipped) only when using brake pedals to assist in slow speed turns in work applications.

Make sure that the brakes are adjusted correctly so the compact tractor does not pull to one side when braking.

W-3060-0919

## **WARNING**

### **AVOID INJURY OR DEATH**

Use ROPS and fasten the seat belt.

Install the correct ballast.

Never modify equipment or use unapproved implements.

Operate the compact tractor from the operator's seat only.

Keep bystanders away. Never carry riders.

W-3059-0919

**Figure 29**

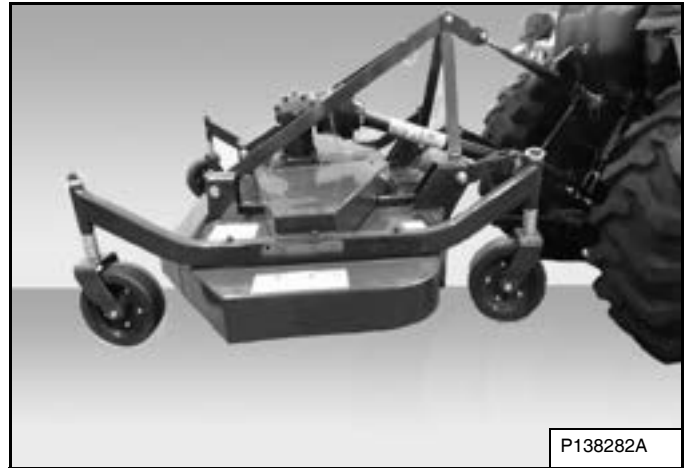

Enter the compact tractor. (See Entering And Exiting The Compact Tractor on Page 23.) Start the engine.

Raise the mower to the travel position [Figure 29]. (See the compact tractor Operation & Maintenance Manual for detailed information on operating the three-point hitch.)

**NOTE: Damage to three-point mower and tractor may be caused if PTO is engaged while in the travel position.**

Drive the compact tractor and implement to the work area.

When operating on a public road or highway, always follow local regulation. For example: Slow Moving Vehicle (SMV) emblem or directional signals and hazard / flasher lights may be required.

## OPERATING PROCEDURE WITH COMPACT TRACTOR (CONT D)

### Operation With The Compact Tractor (Cont d)

#### *Operating The Three-Point Implement*

When at the area to be cleared, lower the three-point mower from the travel position.

**NOTE: Damage to three-point mower and tractor may be caused if PTO is engaged while in the travel position.**

The castor wheels may need to be adjusted to set the cutting height to get the desired finish for the area being cleared. (See Cutting Height Adjustment on Page 52.)

Enter the compact tractor. (See Entering And Exiting The Compact Tractor on Page 23.) Start the engine.

#### *Engaging PTO*

**NOTE: DO NOT operate the mower in the raised position.**

With the mower set to the desired height, move the Engine Speed Control lever to low engine speed. Press the brake pedal(s) and press down fully on the clutch pedal (if applicable).

Engage the PTO system (see the compact tractor's Operation & Maintenance Manual).

Slowly release the clutch pedal (if applicable).

The PTO driveline will start to rotate and the mower blades will begin to turn. Move the engine speed lever to increase engine speed to the correct RPM as indicated on the tachometer. This will cause the PTO shaft to rotate at 540 rpm. Do Not exceed a PTO speed of 540 rpm.

## IMPORTANT

**To avoid start-up overload on PTO driveline, reduce engine speed to low idle when engaging the PTO. After PTO driveline is rotating, increase engine speed.**

I-2272-0812

Engage the forward travel function of the compact tractor. (See the compact tractor's Operation & Maintenance Manual for correct procedure.)



## WARNING

### AVOID INJURY OR DEATH

**Keep bystanders away when the mower is operating. Objects can be thrown several hundred feet. Stop the attachment / implement when bystanders are in the vicinity.**

W-2703-0308

## OPERATING PROCEDURE WITH COMPACT TRACTOR (CONT D)

### Operation With The Compact Tractor (Cont d)

#### *Disengaging PTO*

Move the engine speed lever back to the low idle position. Press the brake pedal(s) and press down fully on the clutch pedal (if applicable).

Disengage the rear-PTO system (see the compact tractor's Operation & Maintenance Manual).

Slowly release the clutch pedal (if applicable).



## WARNING

### AVOID INJURY OR DEATH

**Before you leave the operator s seat:**

**Fully lower the loader arms, put the attachment flat on the ground (if equipped).**

**Fully lower the implement(s) to the ground (if equipped).**

**Lock brake pedals together (if equipped) and engage the parking brake.**

**Place all controls in neutral.**

**Stop the engine, unfasten the seat belt and remove the key.**

---

Always park on flat level ground. Fully lower the loader arms and put the implement flat on the ground (if equipped). Lock brake pedals together (if equipped) and engage the parking brake.

Place all controls in NEUTRAL. Stop the engine and exit the compact tractor. (See Entering And Exiting The Compact Tractor on Page 23.)

## OPERATING PROCEDURE WITH COMPACT TRACTOR (CONT D)

### Removal

#### *Removing The Three-Point Implement*

**NOTE:** In muddy conditions or to prevent the implement from freezing to the ground, put the implement on planks or blocks before removing the implement from the machine.

## **WARNING**

### **AVOID INJURY OR DEATH**

**Before you leave the operator s seat:**

**Fully lower the loader arms, put the attachment flat on the ground (if equipped).**

**Fully lower the implement(s) to the ground (if equipped).**

**Lock brake pedals together (if equipped) and engage the parking brake.**

**Place all controls in neutral.**

**Stop the engine, unfasten the seat belt and remove the key.**

---

Always park on flat level ground. Fully lower the loader arms and put the implement flat on the ground (if equipped). Lock brake pedals together (if equipped) and engage the parking brake.

Place all controls in neutral. Stop the engine and exit the compact tractor. (See Entering And Exiting The Compact Tractor on Page 23.)

Make sure the PTO driveline and all rotating components have come to a complete stop before exiting the compact tractor (if applicable).

Disconnect the PTO driveline (if applicable). (See Removal on Page 30.)

**Figure 30**

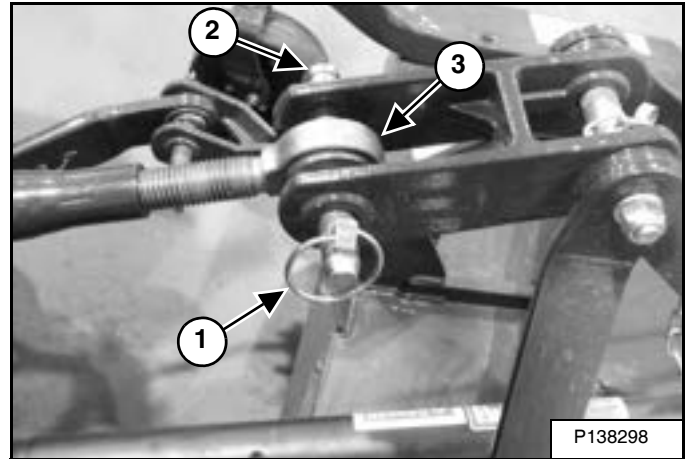

Remove the retainer pin (Item 1) and pin (Item 2) [Figure 30].

**NOTE:** It may be necessary to lengthen or shorten the top link for pin (Item 2) [Figure 30] removal. (See Top Link Adjustment on Page 26.)

Remove the top link (Item 3) [Figure 30] from the implement.

**Figure 31**

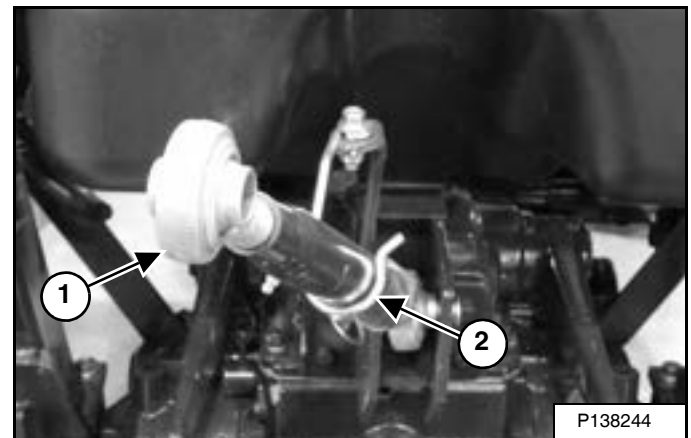

Place the top link (Item 1) into the storage position bracket (Item 2) [Figure 31].

## OPERATING PROCEDURE WITH COMPACT TRACTOR (CONT D)

### Removal (Cont d)

#### *Removing The Three-Point Implement (Cont'd)*

**Figure 32**

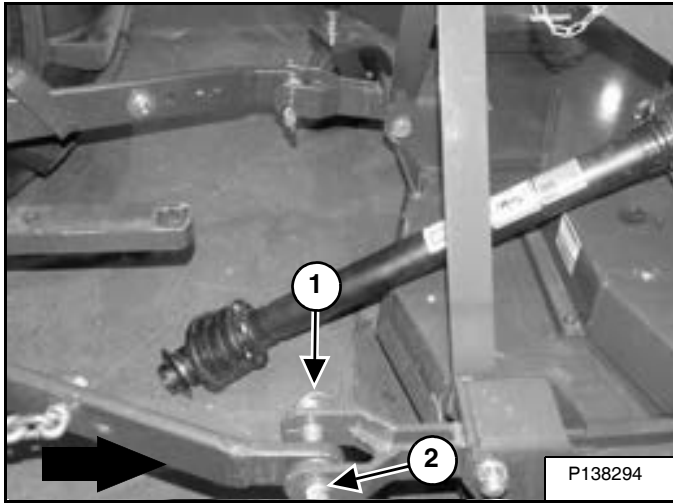

Remove the retainer pins (Item 1) and the implement mounting pins (Item 2) **[Figure 32]** (both sides).

Enter the compact tractor. (See Entering And Exiting The Compact Tractor on Page 23.) Start the engine.

Slowly drive the compact tractor away from the implement.

Reinstall the implement mounting pins (Item 1) and the retaining pins (Item 2) **[Figure 32]** (both sides).

## LIFTING THE IMPLEMENT

### Procedure

Figure 33

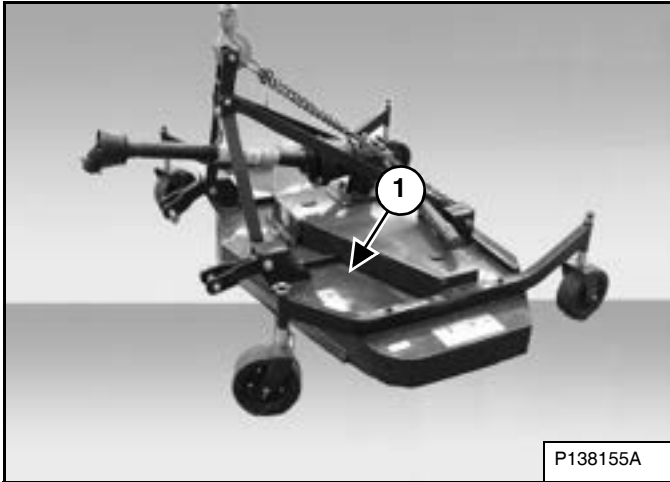

Fasten the chain to the three-point mower (Item 1) [Figure 33].

**NOTE: Use chains that are in good condition and of adequate size to lift the implement.**

## TRANSPORTING THE IMPLEMENT ON A TRAILER

### Fastening

Figure 34

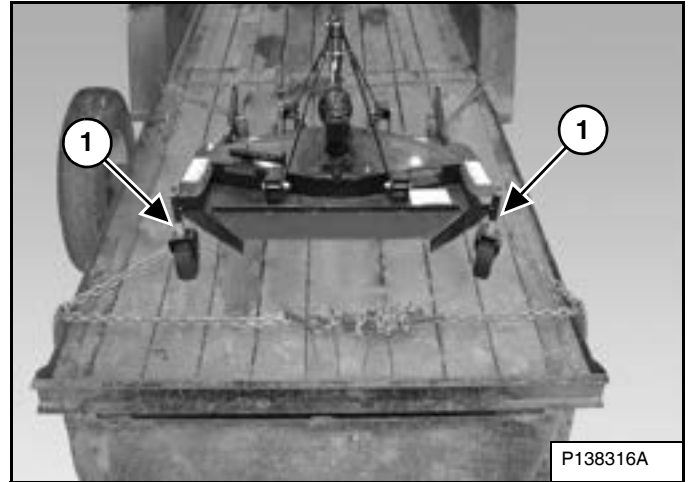

Fasten the chains (Item 1) [Figure 34] to the three-point mower and fasten each end of the chain to the transport vehicle.

Use chain binders to prevent the implement from moving during transport.

Secure the PTO shaft to the mower.

## **TRANSPORTING THE IMPLEMENT AND MACHINE ON A TRAILER**

### **Loading And Fastening**

#### *Loading And Unloading*

Load the implement towards the front of the transport vehicle.

See the correct machine's Operation & Maintenance Manual to properly load and unload the machine on a transport vehicle.

#### *Fastening*

See the correct machine's Operation & Maintenance Manual to properly chain the implement and machine to the transport vehicle.

## PREVENTIVE MAINTENANCE

MAINTENANCE SAFETY .....	45
TROUBLESHOOTING .....	47
Chart .....	47
SERVICE SCHEDULE .....	48
Description .....	48
REGULAR MAINTENANCE ITEMS .....	49
Blade Belt Adjustment .....	49
Blade Belt Replacement .....	50
Blade Sharpening .....	51
Cutting Height Adjustment .....	52
Cleaning The Mower .....	53
LUBRICATING THE IMPLEMENT .....	54
Lubrication Locations .....	54
Gearbox Oil Level .....	56
BLADE .....	57
Removal And Installation .....	57
GEARBOX .....	58
Removal And Installation .....	58
BLADE SPINDLE .....	61
Removal And Installation .....	61
IMPLEMENT STORAGE AND RETURN TO SERVICE .....	63
Storage .....	63
Return To Service .....	63



# MAINTENANCE SAFETY



## WARNING







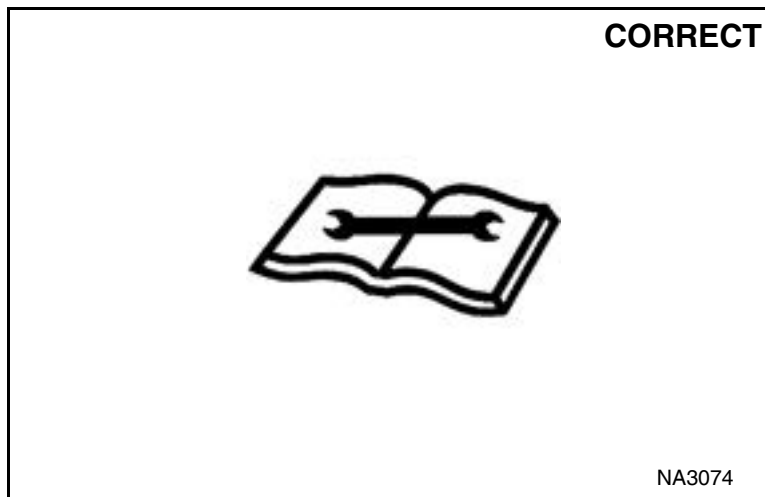

Instructions are necessary before operating or servicing machine. Read and understand the Operation & Maintenance Manual, Operator's Handbook and signs (decals) on machine. Follow warnings and instructions in the manuals when making repairs, adjustments or servicing. Check for correct function after adjustments, repairs or service. Untrained operators and failure to follow instructions can cause injury or death.

W-2003-0807



**Safety Alert Symbol:** This symbol with a warning statement, means: Warning, be alert! Your safety is involved! Carefully read the message that follows.



-  **Never service attachments / implements without instructions. See Operation & Maintenance Manual and Attachment / Implement Service Manual.**
-  **Cleaning and maintenance are required daily.**
-  **Never service or adjust attachment / implement with the engine running unless instructed to do so in manual.**
-  **Always lower the attachment / implement to the ground before lubricating or servicing.**
-  **Avoid contact with leaking hydraulic fluid or diesel fuel under pressure. It can penetrate skin or eyes.**
-  **Stop, cool and clean engine of flammable materials before checking fluids.**
-  **Keep body, loose objects and clothing away from moving parts, electrical contacts, hot parts and exhaust.**
-  **Safety glasses are needed for eye protection from electrical arcs, battery acid, compressed springs, fluids under pressure and flying debris or when tools are used. Use eye protection approved for type of welding.**

MSW30-0320



## TROUBLESHOOTING

### Chart

 <b>WARNING</b>	<p>Instructions are necessary before operating or servicing machine. Read and understand the Operation &amp; Maintenance Manual and signs (decals) on machine. Follow warnings and instructions in the manuals when making repairs, adjustments or servicing. Check for correct function after adjustments, repairs or service. Untrained operators and failure to follow instructions can cause injury or death.</p>	<p>W-2408-0801</p>
--	---	--------------------

Use the following troubleshooting chart to locate and correct problems which most often occur with the implement.

TROUBLESHOOTING THE MOWER		
PROBLEM	CAUSE	CORRECTION
Poor cutting.	Travel speed too fast.	Reduce travel speed.
	Damaged gearbox.	Repair or replace gearbox.
	Blade belt slipping	Adjust belt to correct tension.
	Blades dull.	Sharpen or replace the blades.
Blades will not rotate.	Worn or broken blade belt.	Replace belt.
	PTO driveline disconnected.	Connect PTO driveline.
Vibration.	Build up of material on the bottom of the mower deck.	Clean the bottom of the mower deck.
	Loose or cracked hardware.	Repair or replace as needed.
	Blades worn or broken.	Replace the blades.
	Blade spindles bent.	Replace spindles.
	Blades not balanced.	Balance or replace blades.

## SERVICE SCHEDULE

### Description

Maintenance work must be done at regular intervals. Failure to do so will result in excessive wear and early failures. The service schedule is a guide for correct maintenance of the Ignite product.



**WARNING**

Instructions are necessary before operating or servicing machine. Read and understand the Operation & Maintenance Manual, Handbook and signs (decals) on machine. Follow warnings and instructions in the manuals when making repairs, adjustments or servicing. Check for correct function after adjustments, repairs or service. Untrained operators and failure to follow instructions can cause injury or death.

W-2003-0199

SERVICE SCHEDULE		FREQUENCY		
ITEM	SERVICE REQUIRED	DAILY	40 HOURS	400 HOURS/ YEARLY
Implement Frame Inspection	Inspect for cracks or damage.	X		
Check All Hardware	Replace any missing or damaged bolts or nuts.	X		
Check Blades	Check for damage and replace or sharpen as required.	X		
Grease PTO Shaft And All Grease Fittings	Grease PTO shaft and knuckles.	X		
Gearbox Lubrication Level	Check for proper level of fluid.		X	
Change Lubrication	Change Gearbox Oil			X

## REGULAR MAINTENANCE ITEMS

### Blade Belt Adjustment

**NOTE:** The belt tensioning can be done on either the left or right side of the mower. The left side is shown.

**Figure 35**

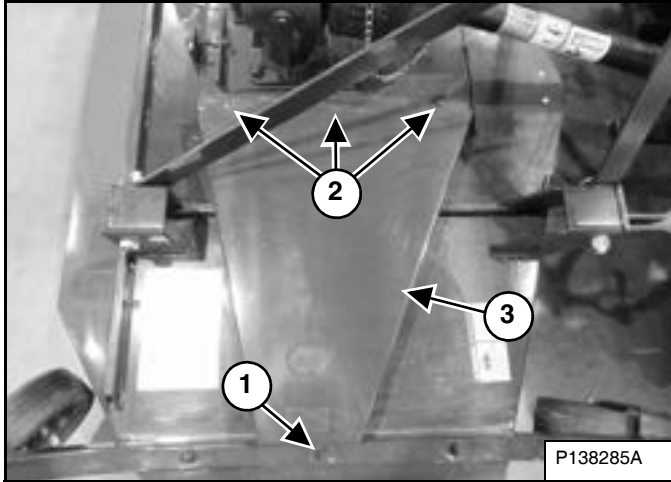

Remove the nut, bolt and washer (Item 1) [Figure 35] (both sides).

Remove the three bolts (Item 2) [Figure 35] (both sides).

Remove the cover (Item 3) [Figure 35] (both sides).

**Figure 36**

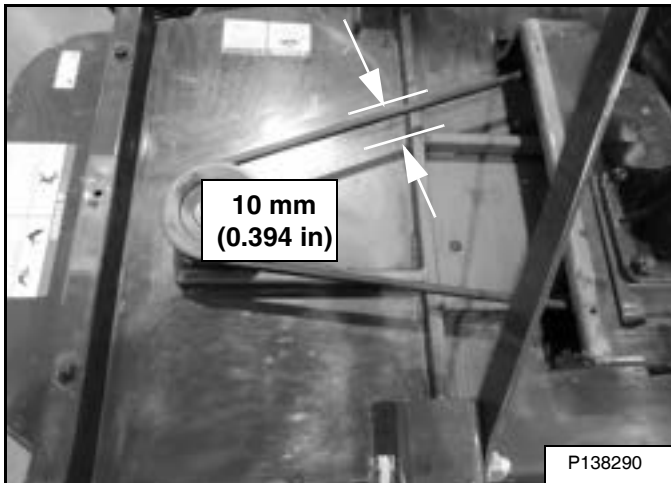

When a new belt is properly adjusted, the belt will have 10 mm (0.394 in) of deflection when a force of 5,2 - 5,5 kg (11.4 - 12.2 lb) is applied where shown [Figure 36].

When a used belt is properly adjusted, the belt will have 10 mm (0.394 in) of deflection when a force of 4,4 - 4,8 kg (9.8 - 10.6 lb) is applied where shown [Figure 36].

**Figure 37**

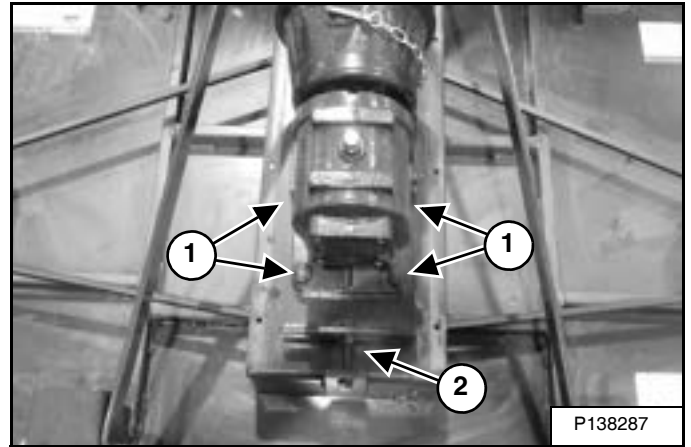

If the belt needs to be adjusted, loosen the four gearbox slide plate nuts (Item 1) [Figure 37].

The belt adjuster (Item 2) [Figure 37] is located at the rear of the gear box mount.

**Figure 38**

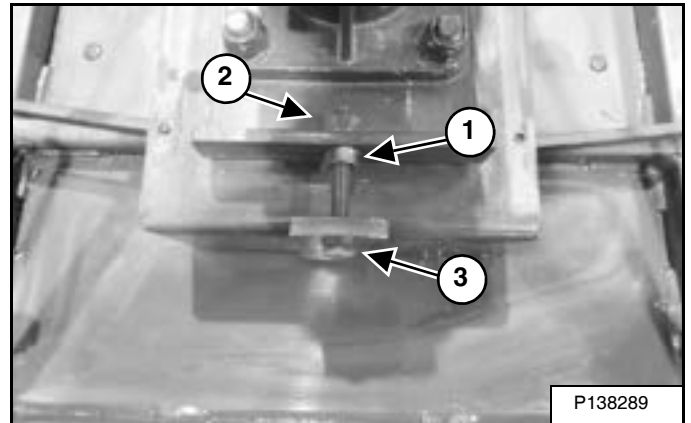

Loosen the nut (Item 1), hold the nut (Item 2), and turn the gearbox adjustment bolt (Item 3) until the belt has the correct tension. Tighten the nut (Item 1) [Figure 38].

## REGULAR MAINTENANCE ITEMS (CONT D)

### Blade Belt Replacement

Figure 39

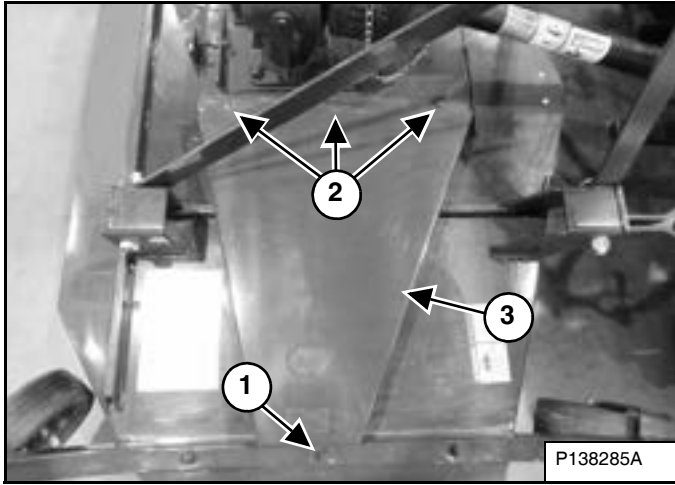

Remove the nut, bolt and washer (Item 1) [Figure 39] (both sides).

Remove the three bolts (Item 2) [Figure 39] (both sides).

Remove the cover (Item 3) [Figure 39] (both sides).

Figure 40

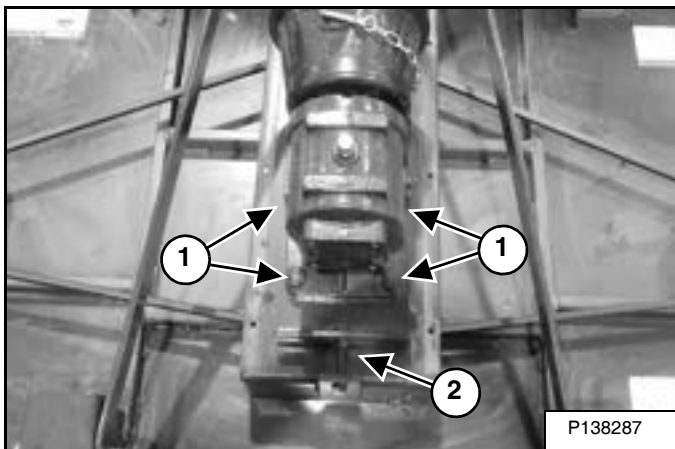

Loosen gearbox slide plate nuts (Item 1) and the gearbox adjustment bolt (Item 2) [Figure 40] slide the gearbox to the full forward position.

Figure 41

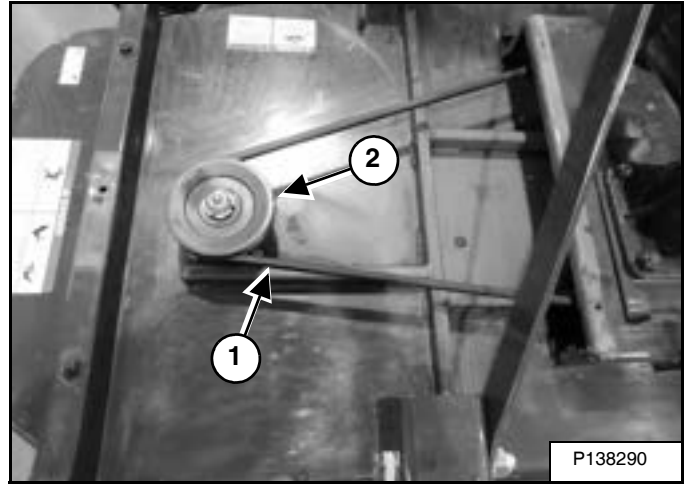

Remove the blade belt (Item 1) from the blade pulley (Item 2) [Figure 41].

Figure 42

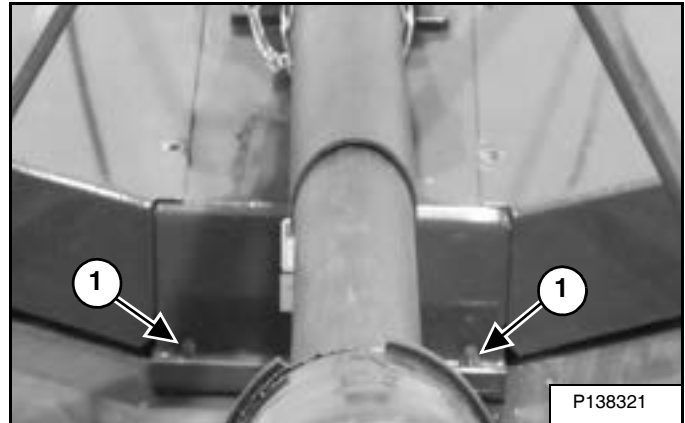

Remove the two nuts, bolts and washers (Item 1) [Figure 42].

## REGULAR MAINTENANCE ITEMS (CONT D)

### Blade Belt Replacement (Cont d)

Figure 43

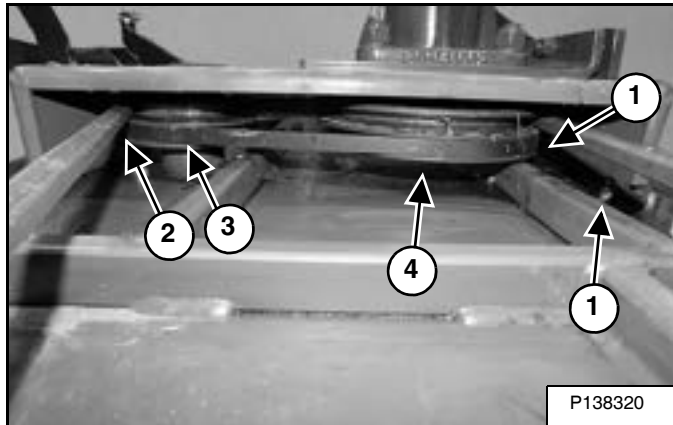

Remove the two nuts, bolts and washers (Item 1) then slightly raise the gearbox mount and lift the belts (Item 2) over the center spindle pulley (Item 3) and under the gearbox pulley (Item 4) [Figure 43].

Figure 44

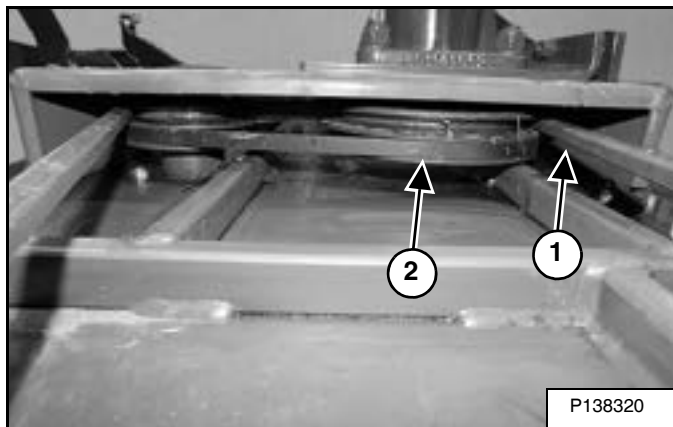

During assembly ensure the left-hand belt (Item 1) is in the upper groove of the gearbox pulley [Figure 44].

During assembly ensure the right-hand belt (Item 2) is in the lower groove of the gearbox pulley [Figure 44].

**NOTE: Always replace both belts at the same time and use belts of the same type and size.**

## Blade Sharpening

Figure 45

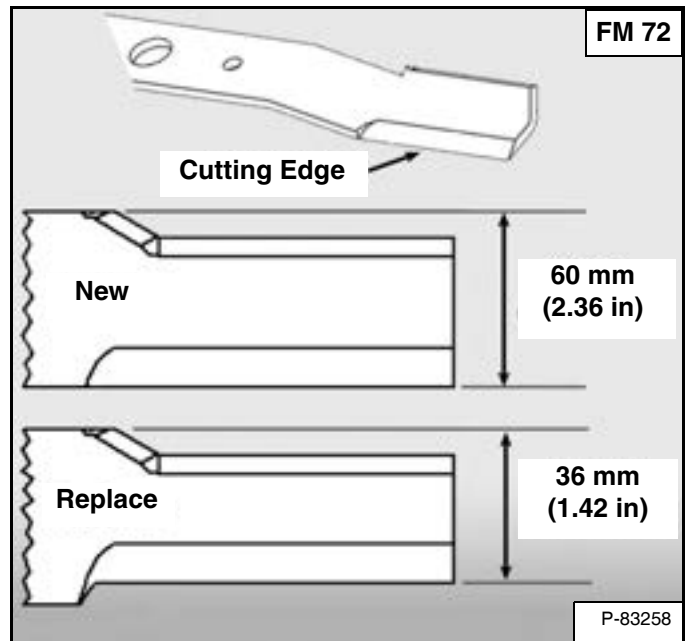
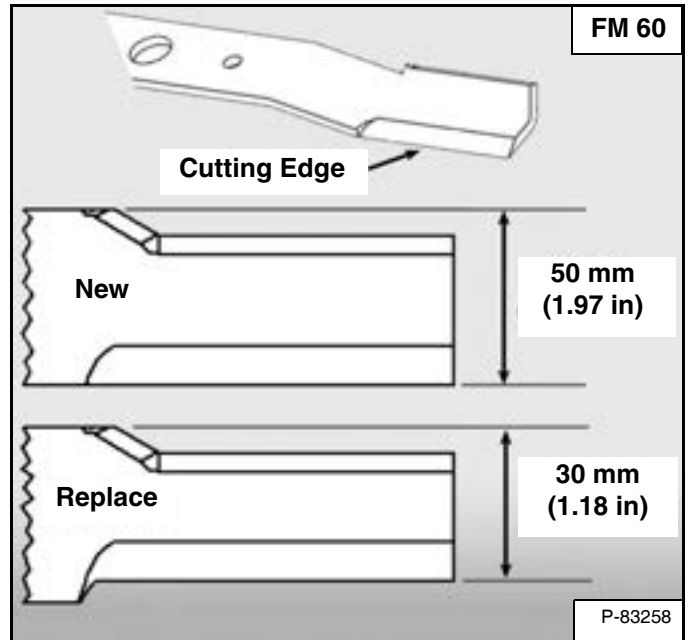

When the cutting edge of the blades become dull, remove the blades and have a sharpening service sharpen at a 28 degree angle and balance the blades.

Replace the blades when they reach a width of 30 mm (1.18 in) for FM 60 and 36 mm (1.42 in) for FM 72 mowers [Figure 45].

Always replace all three blades with blades that are equal in weight to prevent vibration.

If any vibration in the mower is felt, the blades must be balanced or replaced.

## REGULAR MAINTENANCE ITEMS (CONT D)

### Cutting Height Adjustment

Figure 46

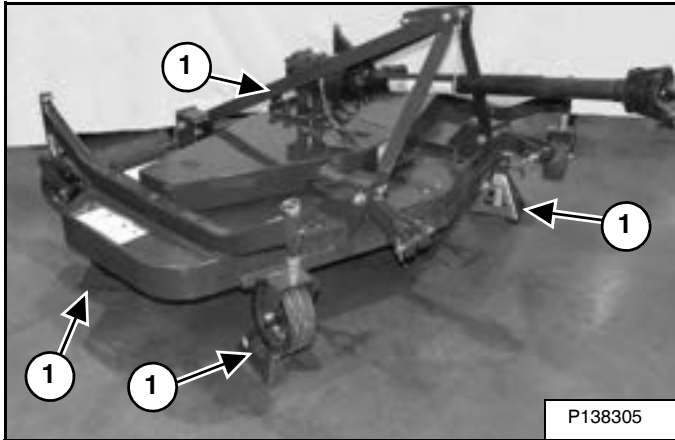

Raise the mower deck and place stands (Item 1) [Figure 46] under the mower deck.

Figure 47

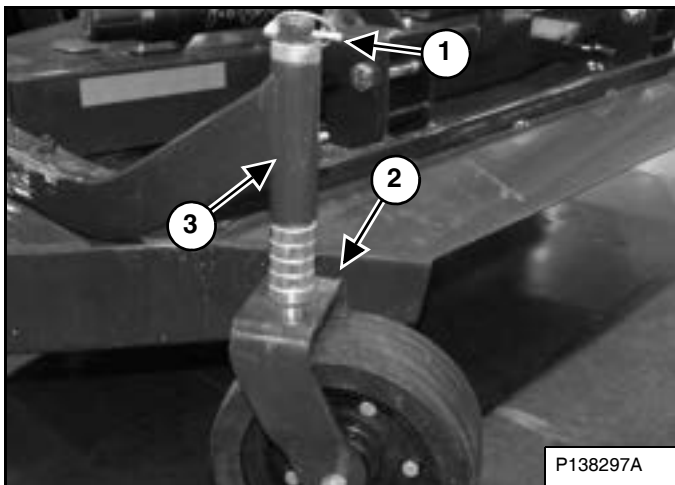

Remove the retaining pins (Item 1) [Figure 47].

Remove the wheel fork (Item 2) from the wheel mounting (Item 3) [Figure 47].

Figure 48

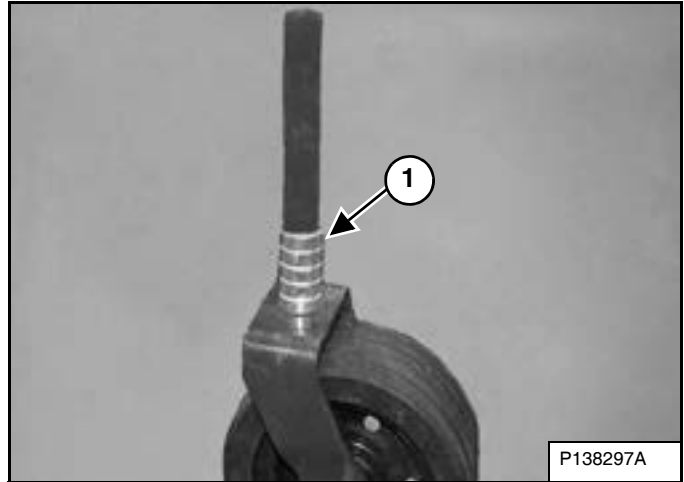

Remove or add spacers (Item 1) [Figure 48] in 13 mm (.50 in) increments to achieve the required cutting height.

Re-install the wheel fork through the wheel mounting. Place remaining spacers onto the wheel fork and install the retaining pin.

**NOTE: All castor wheels must be adjusted the same for correct mower operation.**

## REGULAR MAINTENANCE ITEMS (CONT D)

### Cleaning The Mower

Remove the mower from the compact tractor. (See Removal on Page 39.)

Install chains and lift the mower. (See LIFTING THE IMPLEMENT on Page 41.)

Figure 49

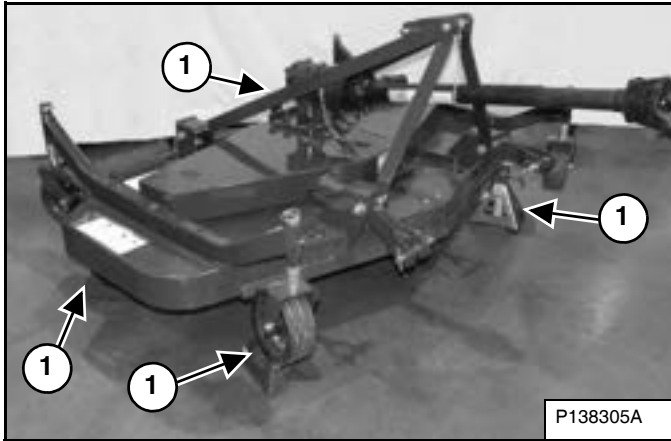

Lower the mower and place on jackstands. Position the four jackstands (Item 1) as shown in [Figure 49].



#### AVOID INJURY OR DEATH

**Wear safety glasses to prevent eye injury when any of the following conditions exist:**

- When fluids are under pressure.**
- Flying debris or loose material is present.**
- Engine is running.**
- Tools are being used.**

W-2019-0907

Use water or air pressure to clean debris from the bottom of the mower deck.

Use care when removing any objects that are wrapped around blades and blade shafts.

Figure 50

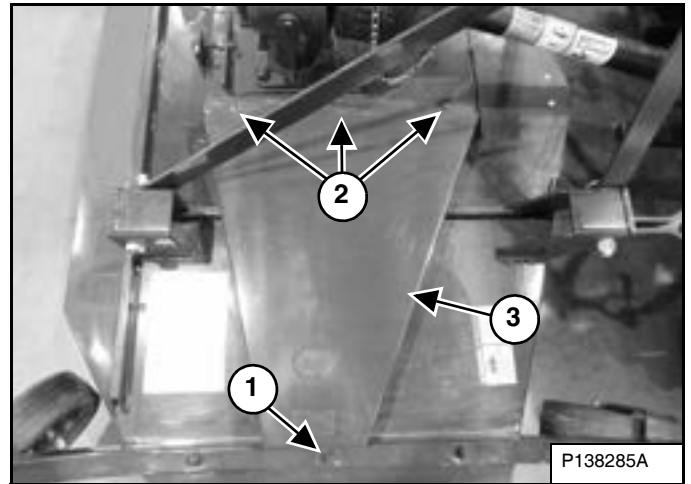

Remove the nut, bolt and washer (Item 1) [Figure 50] (both sides).

Remove the three bolts (Item 2) [Figure 50] (both sides).

Remove the cover (Item 3) [Figure 50] (both sides).

Figure 51

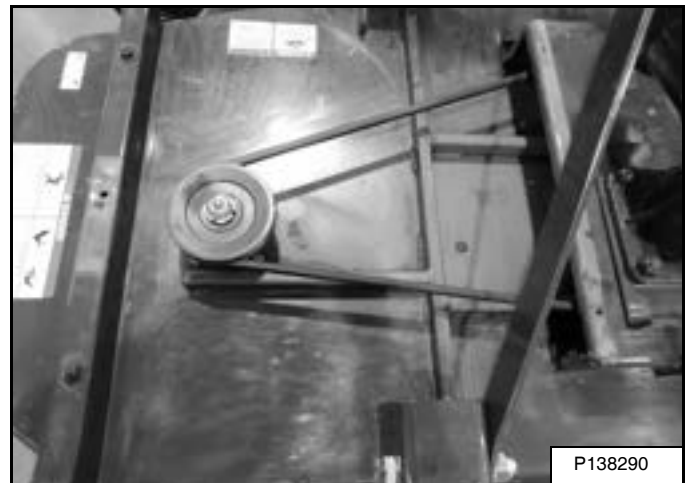

Use water or compressed air to clean debris from under the covers [Figure 51].

Reinstall covers.

## LUBRICATING THE IMPLEMENT

### Lubrication Locations

Always use a good quality lithium base multi purpose grease when lubricating the implement. Apply the lubricant until extra grease shows.

# IMPORTANT

Fluid such as engine oil, hydraulic fluid, coolants, grease, etc. must be disposed of in an environmentally safe manner. Some regulations require that certain spills and leaks on the ground must be cleaned in a specific manner. See local, state and federal regulations for the correct disposal.

I-2067-0499

Lubricate the following grease fittings every **10 hours**:

**Figure 52**

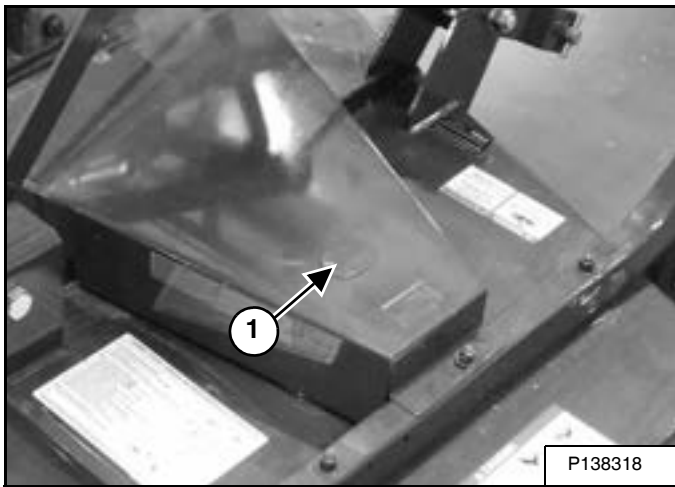

1. Left blade spindle (Qty. 1) (Item 1) **[Figure 52]** (remove the rubber plug).

**Figure 53**

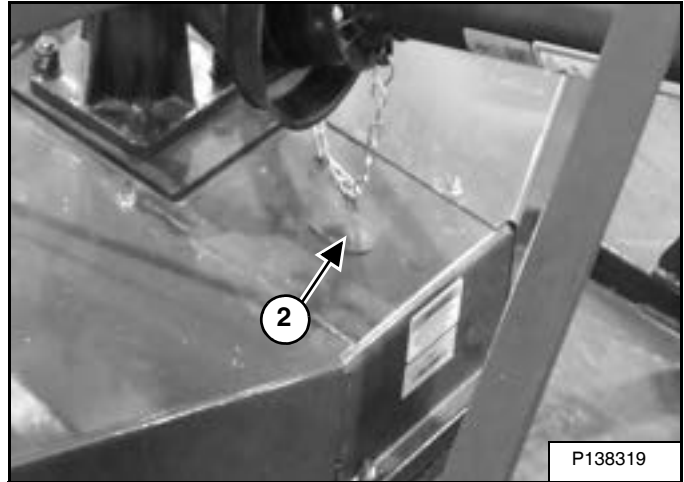

2. Center blade spindle (Qty. 1) (Item 2) **[Figure 53]** (remove the rubber plug).

**Figure 54**



3. Right blade spindle (Qty. 1) (Item 3) **[Figure 54]** (remove the rubber plug).

## LUBRICATING THE IMPLEMENT (CONT D)

### Lubrication Locations (Cont d)

Figure 55

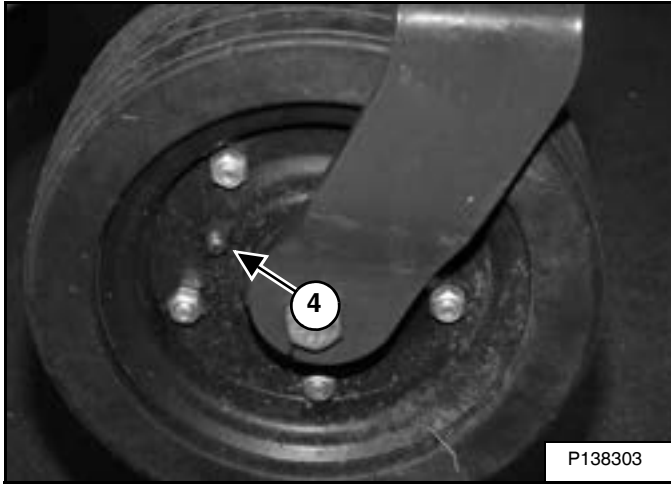

4. Castor wheel bearings (Qty. 4) (Item 4) [Figure 55].

Figure 56

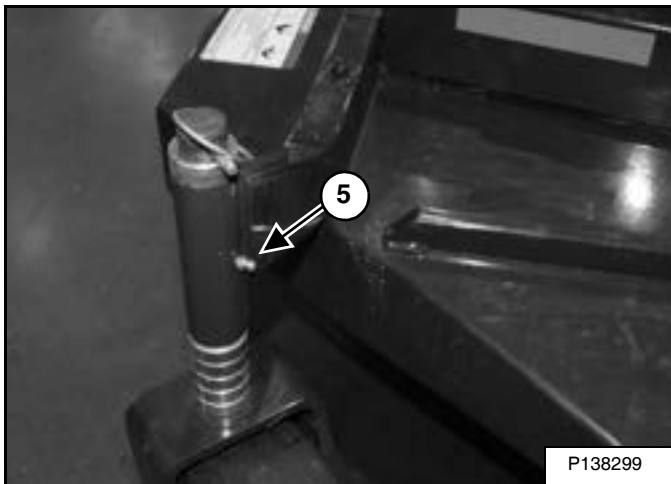

5. Castor wheels (Qty. 4) (Item 5) [Figure 56].

Figure 57

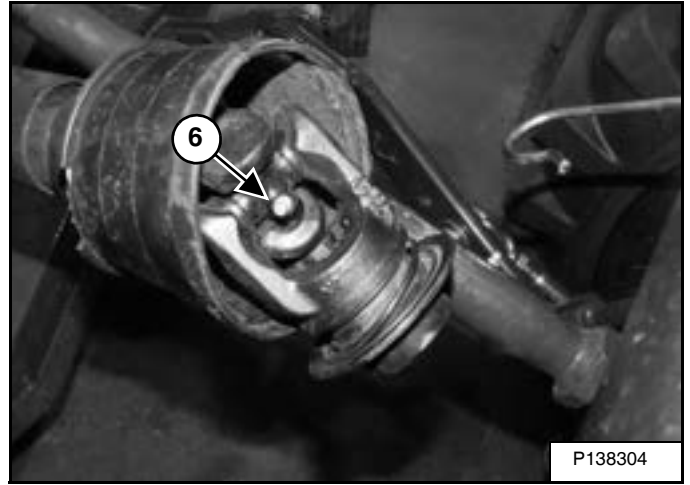

6. PTO shaft knuckle (Qty. 1) (Item 6) [Figure 57] (compact tractor side).

Figure 58

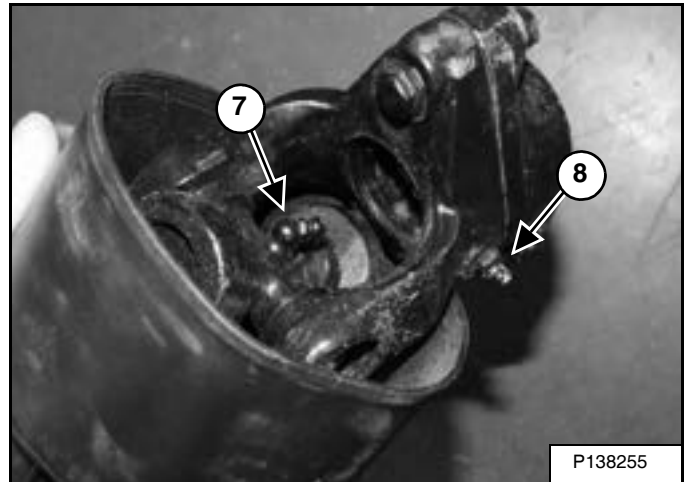

7. PTO shaft knuckle (Qty. 1) (Item 7) [Figure 58] (gearbox side).

8. PTO shaft yoke (Qty. 1) (Item 8) [Figure 58] (gearbox side).

## LUBRICATING THE IMPLEMENT (CONT D)

### Lubrication Locations (Cont d)

Figure 59

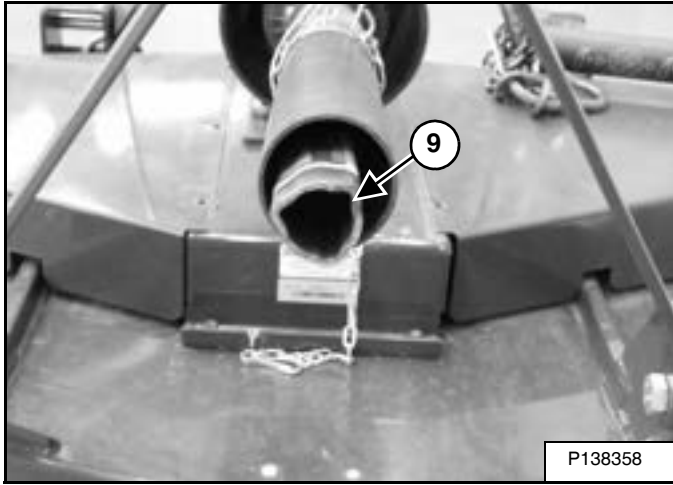

9. Inside PTO Outer Tube (Qty. 1) (Item 9) [Figure 56].

### Gearbox Oil Level

Figure 60

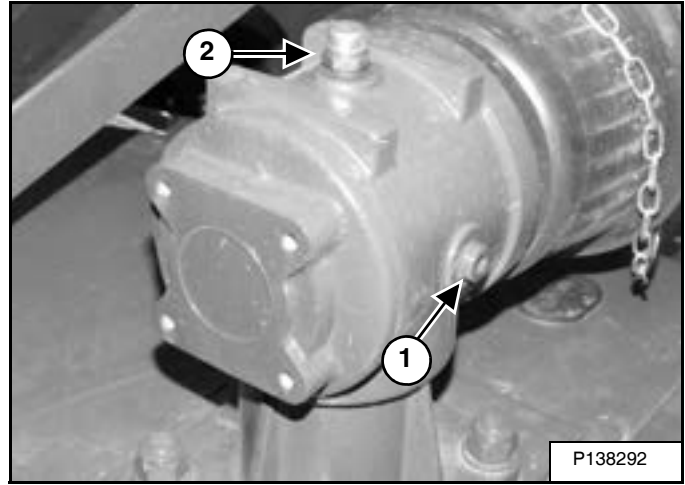

Remove the oil level plug (Item 1) [Figure 60]. If oil is level with oil level plug hole, reinstall plug.

If the oil is low, remove the vent/fill plug (Item 2) [Figure 60] and add oil (80W-90 Gear Lube) to the correct level. Reinstall plugs.

## BLADE

### Removal And Installation

Block the implement securely off the ground to gain access to the blades.

**Figure 61**

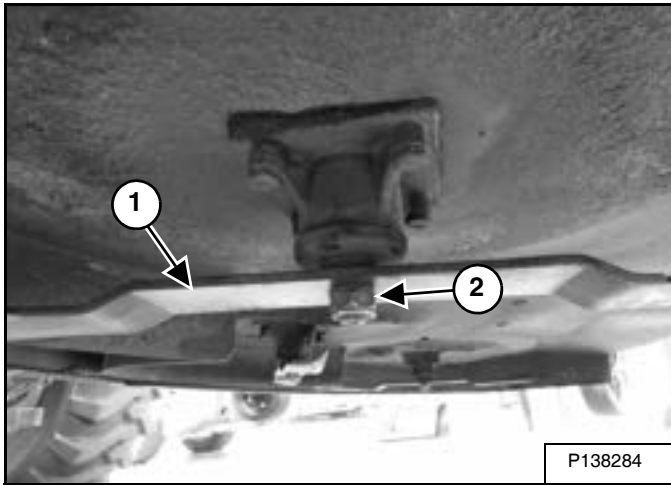

Hold the blade (Item 1) and remove the nut (Item 2) [Figure 61] and washer.

**Installation:** Tighten the bolt in the clockwise direction to torque.

## GEARBOX

### Removal And Installation

Stop the compact tractor and implement on a flat, level surface. Lower the implement to the ground and engage the parking brake.

Stop the engine, unfasten the seat belt and remove the key.

Exit the compact tractor.

(See the compact tractor's Operation & Maintenance Manual for detailed information on operating the compact tractor.)

## WARNING

### AVOID INJURY OR DEATH

Disengage PTO (rear and mid), engage the parking brake, stop the engine and make sure all rotating components are stopped before exiting machine.

Do NOT service the machine or implement with the PTO (rear or mid) engaged.

Do NOT service the implement unless all rotating components have stopped.

W-2834-0110

Make sure the PTO driveline and all rotating components have come to a complete stop before exiting the machine.

Remove the PTO driveline. (See Removal on Page 30.)

## WARNING

### AVOID INJURY OR DEATH

Securely block up the attachment / implement before working underneath.

W-2565-0123

Figure 62

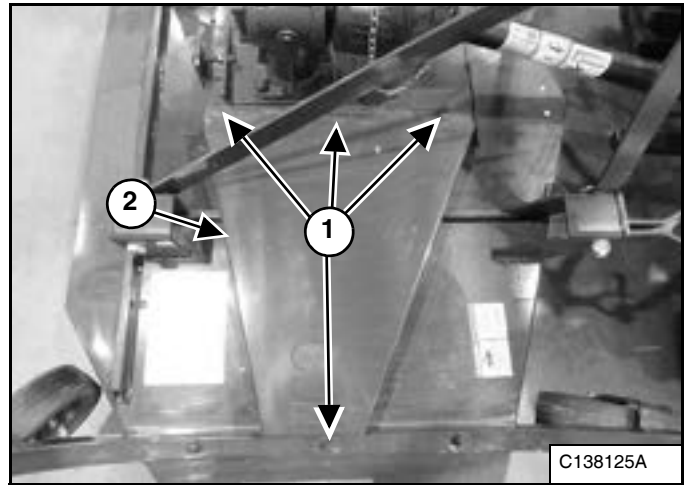

Remove the four bolts (Item 1) and remove the belt guard (Item 2) [Figure 62] (both sides of mower).

**Installation:** Place the belt guard (Item 2) on both sides of mower, then insert bolts (Item 1) and tighten firmly for both guards (Item 2) [Figure 62].

Remove the belt. (See Blade Belt Replacement on Page 50.)

Figure 63

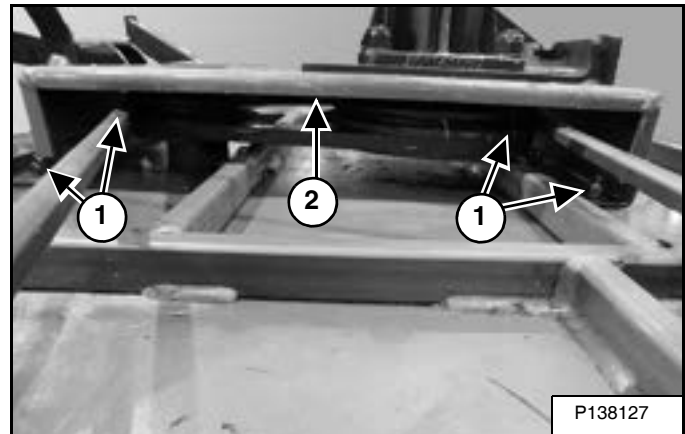

Remove the four bolts / nuts (Item 1) [Figure 63].

Remove the gearbox mount (Item 2) [Figure 63].

## GEARBOX (CONT D)

### Removal And Installation (Cont'd)

Figure 64

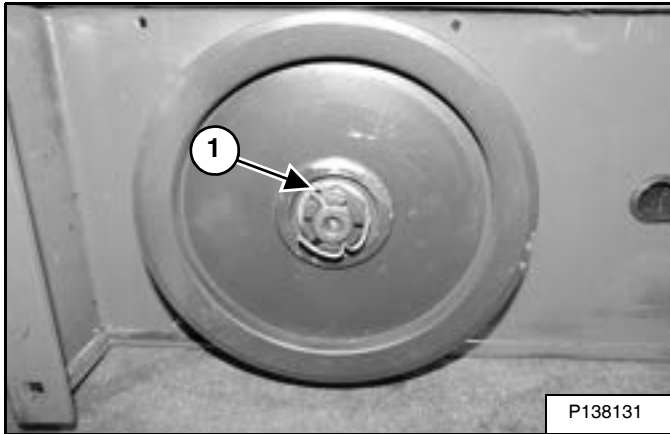

Remove the cotter pin (Item 1) [Figure 64].

**! WARNING**

**AVOID INJURY OR DEATH**

**Never operate with covers or guards removed.**

W-2121-0788

Figure 65

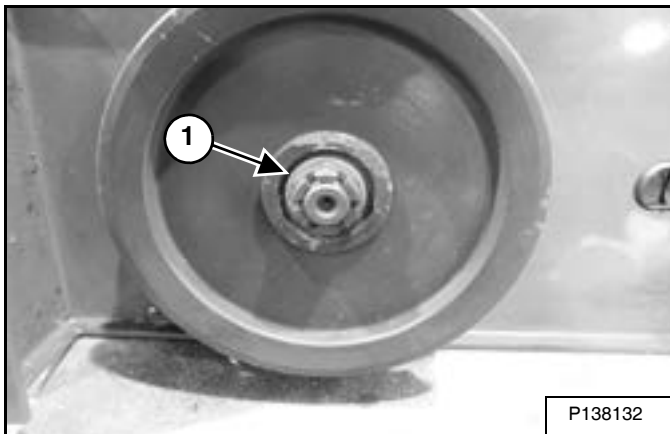

Remove the nut (Item 1) [Figure 65].

**Installation:** Install and tighten castle nut (Item 1) [Figure 65] by hand, aligning nearest groove with through hole in shaft. Install the cotter pin (Item 1) [Figure 65] and bend the ends over.

Figure 66

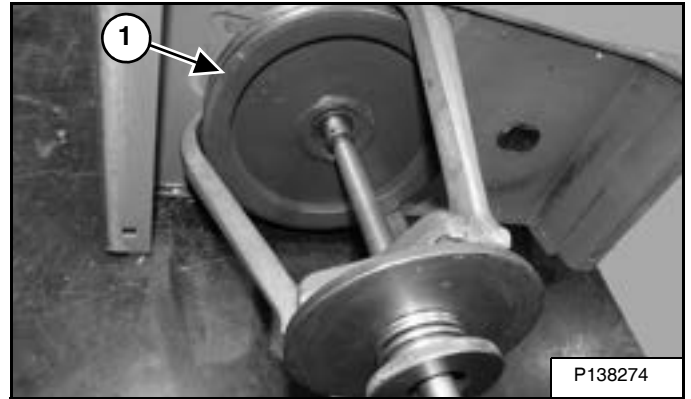

Using a puller, remove the pulley (Item 1) [Figure 66].

Figure 67

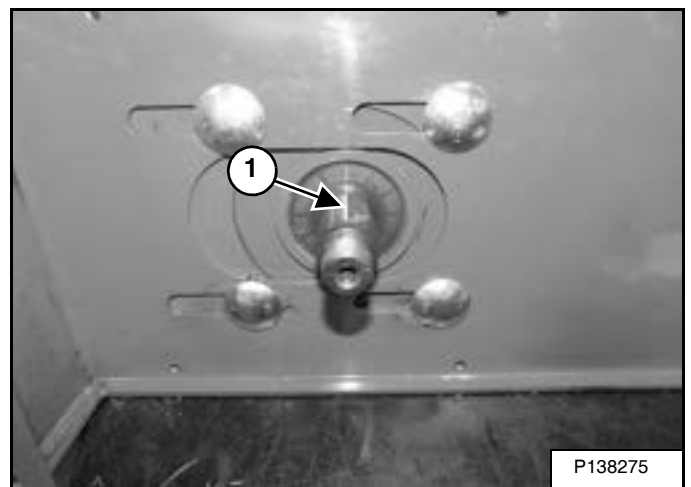

Remove the key (Item 1) [Figure 67].

## GEARBOX (CONT D)

### Removal And Installation (Cont'd)

Figure 68

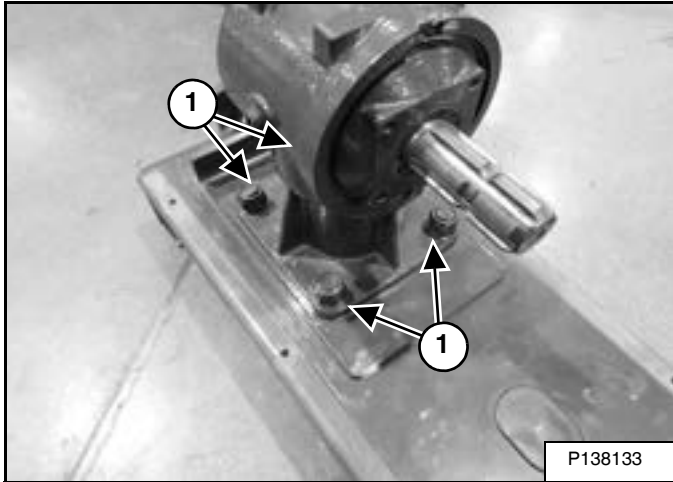

Remove the four bolts / nuts (Item 1) [Figure 68].

**Installation:** Tighten the four bolts and nuts (Item 1) [Figure 68]. Tighten the bolts to 170 - 190 N•m (125 - 140 ft-lb) torque.

Figure 69

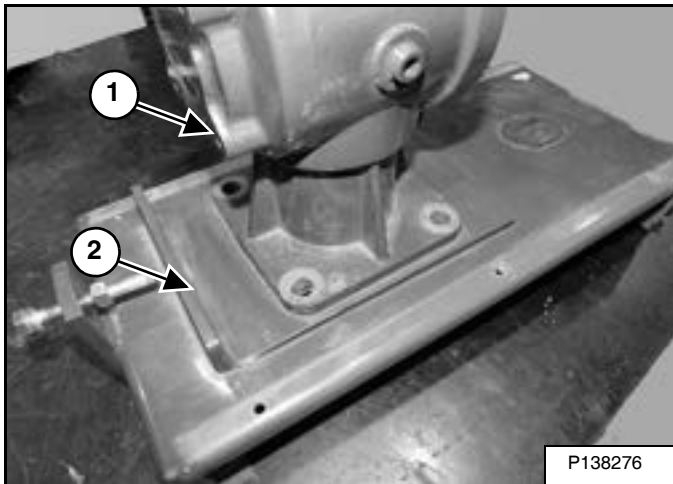

Remove gearbox (Item 1) and mounting plate (Item 2) [Figure 69].

The installation of the gearbox is the reverse of the preceding steps.

## BLADE SPINDLE

### Removal And Installation

Stop the compact tractor and implement on a flat, level surface. Lower the implement to the ground and engage the parking brake.

Stop the engine, unfasten the seat belt and remove the key.

Exit the compact tractor.

(See the compact tractor's Operation & Maintenance Manual for detailed information on operating the compact tractor.)

## WARNING

### AVOID INJURY OR DEATH

Disengage PTO (rear and mid), engage the parking brake, stop the engine and make sure all rotating components are stopped before exiting machine.

Do NOT service the machine or implement with the PTO (rear or mid) engaged.

Do NOT service the implement unless all rotating components have stopped.

W-2834-0110

Make sure the PTO driveline and all rotating components have come to a complete stop before exiting the compact tractor.

Remove the three-point finish mower from the compact tractor. (See the three-point finish mower's Operation & Maintenance Manual for the correct procedure.)

Install chains and lift the three-point finish mower. (See the three-point finish mower's Operation & Maintenance Manual for the correct procedure.)

## WARNING

### AVOID INJURY OR DEATH

Securely block up the attachment / implement before working underneath.

W-2565-0123

Figure 70

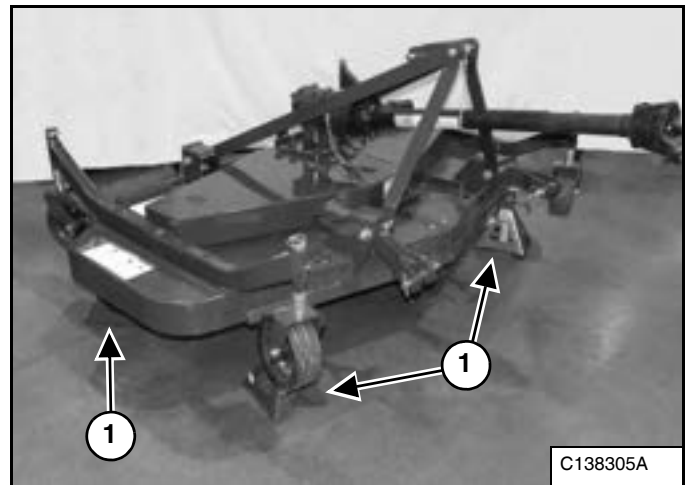

Position the four jackstands as shown in [Figure 70]. Lower the finish mower and place on jackstands.

## WARNING

### AVOID INJURY OR DEATH

Wear safety glasses to prevent eye injury when any of the following conditions exist:

When fluids are under pressure.

Flying debris or loose material is present.

Engine is running.

Tools are being used.

W-2019-0907

Remove the drive belt. (See Blade Belt Replacement on Page 50.)

Remove the cutting blade(s). (See Removal And Installation on Page 57.)

## BLADE SPINDLE (CONT D)

### Removal And Installation (Cont d)

Figure 71

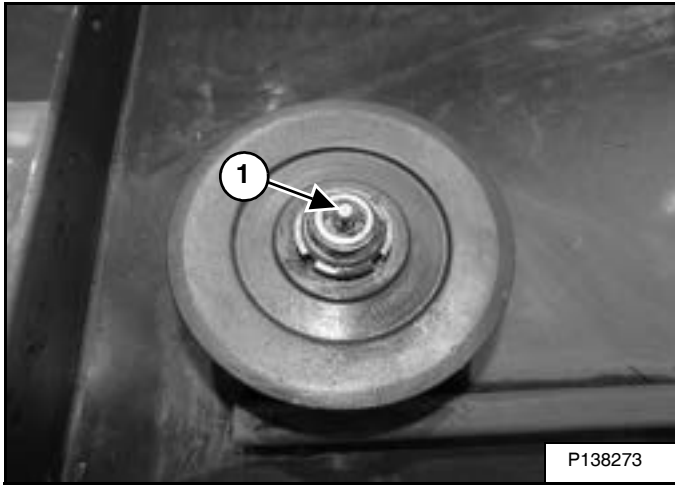

Remove the grease fitting (Item 1) [Figure 71].

Figure 72

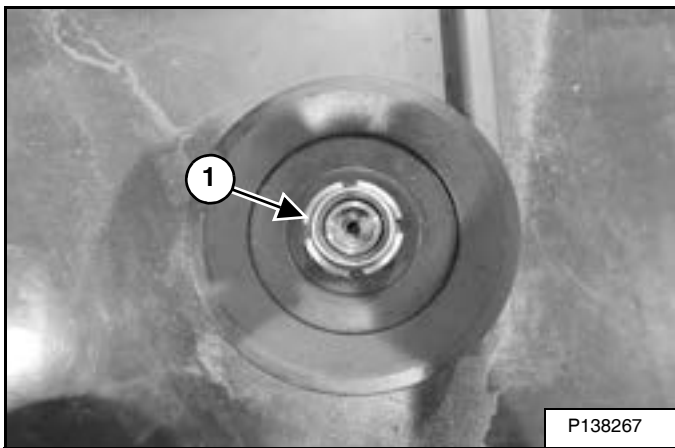

Remove the locking ring (Item 1) [Figure 72].

Figure 73

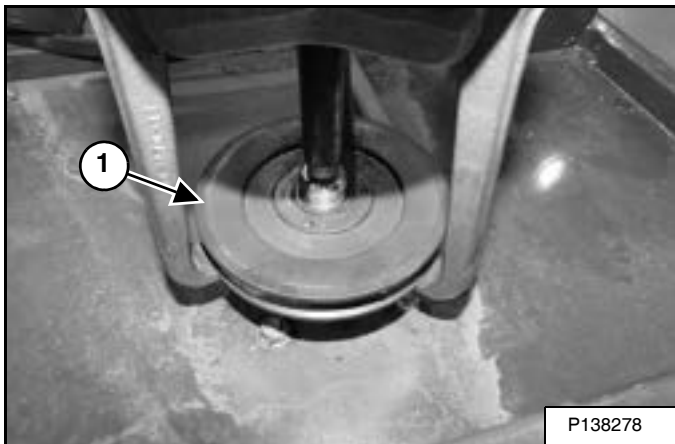

Using a puller, remove the pulley (Item 1) [Figure 73].

Figure 74

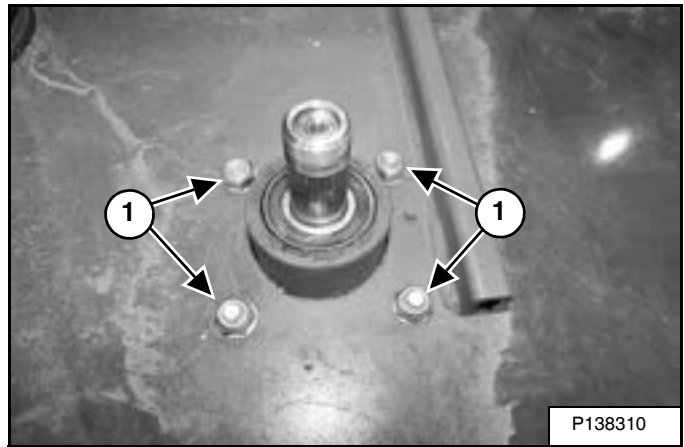

Remove the four bolts / nuts (Item 1) [Figure 74].

Figure 75

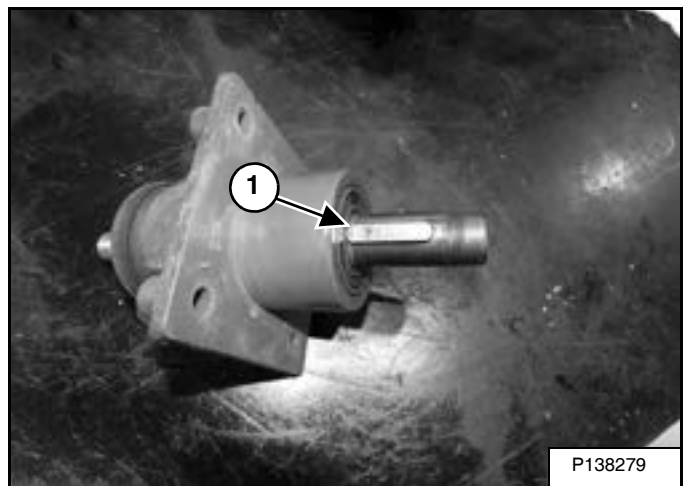

Remove the key (Item 1) [Figure 75].

The installation of the blade spindle is the reverse of the preceding steps.

## IMPLEMENT STORAGE AND RETURN TO SERVICE

### Storage

Sometimes it may be necessary to store your Ignite implement for an extended period of time. Below is a list of items to perform before storage.

- Thoroughly clean the implement.
- Lubricate the implement.
- Inspect the three-point mounts, mounting pins, and all welds on the implement for wear and damage.
- Check for loose hardware, missing guards, or damaged parts.
- Check for damaged or missing decals. Replace if necessary.
- Replace worn or damaged parts.
- Place the implement in a dry protected shelter.
- Place the implement flat on the ground.

**NOTE: In muddy conditions or to prevent the implement from freezing to the ground, put the implement on planks or blocks before removing the implement from the machine.**

### Return To Service

After the Ignite implement has been in storage, it is necessary to follow a list of items to return the implement to service.

- Be sure all shields and guards are in place.
- Lubricate the implement.
- Install and operate implement, check for correct function.
- Check for leaks. Repair as needed.



## SPECIFICATIONS

MOWER SPECIFICATIONS .....	.67
Dimensions .....	.67
Performance .....	.68

Certain specification(s) are based on engineering calculations and are not actual measurements. Specification(s) are provided for comparison purposes only and are subject to change without notice. Specification(s) for your individual Ignite equipment will vary based on normal variations in design, manufacturing, operating conditions, and other factors.



## MOWER SPECIFICATIONS

### Dimensions

- Where applicable, specifications conform to **SAE and ISO** standards and are subject to change without notice.

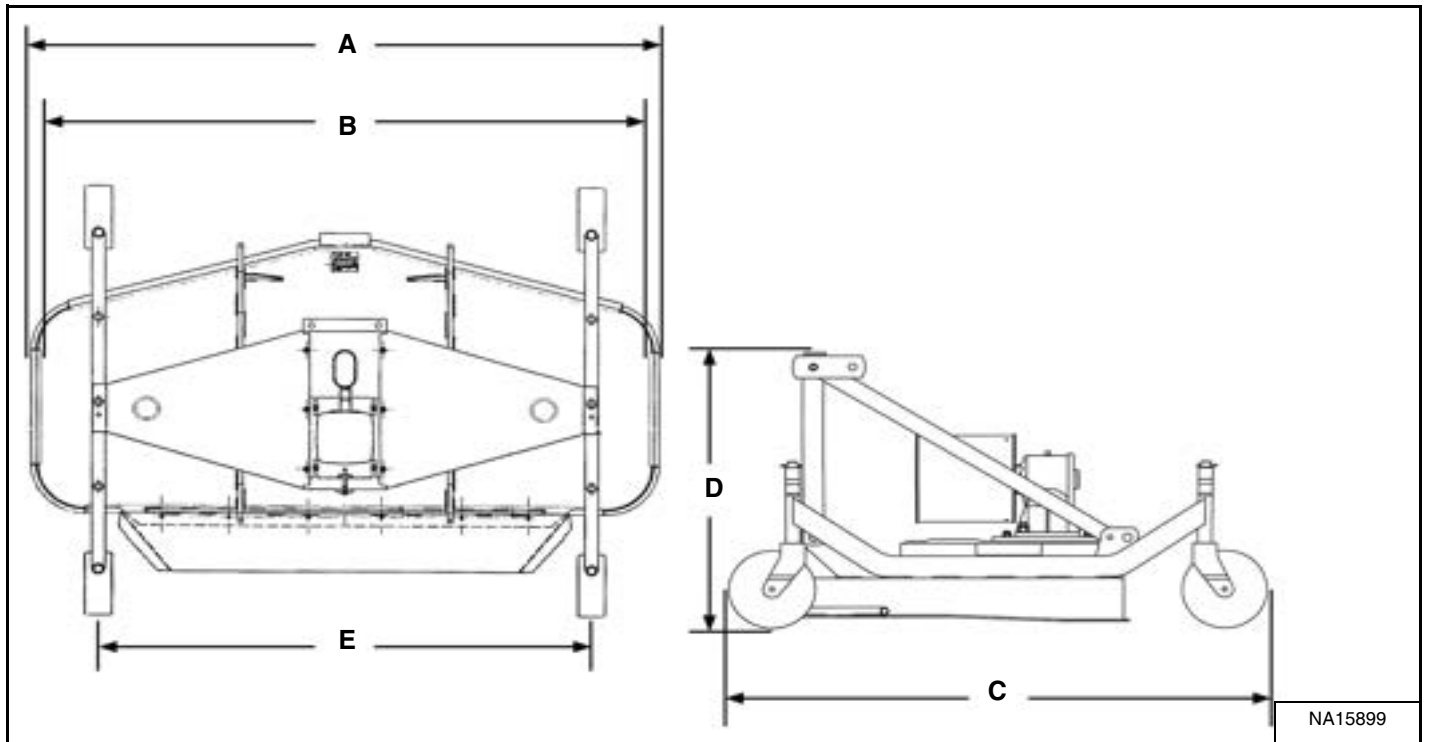

Description	MOWER 60	MOWER 72
Width (A)	1590 mm (62.6 in)	1890 mm (74.41 in)
Cutting Width (B)	1500 mm (59.05 in)	1800 mm (70.87 in)
Length (C)	1400 mm (55.12 in)	1500 mm (59.05 in)
Height (D)	750 mm (29.53 in)	780 mm (30.71 in)
Wheel Width (E)	1270 mm (50.0 in)	1470 mm (57.87 in)

## MOWER SPECIFICATIONS (CONT D)

### Performance

- Where applicable, specifications conform to **SAE and ISO** standards and are subject to change without notice.

Description	MOWER 60	MOWER 72
Weight	190 kg (419 lb)	225 kg (496 lb)
Spindle Type	Ball Bearing	Ball Bearing
Blade Size - Cutting Portion	135 mm (5.31 in) x 50 mm (1.97 in)	135 mm (5.31 in) x 60 mm (2.36 in)
Blade Type	Centered with Lift	Centered with Lift
Number of Blades	3	3
Blade Overlap	5 - 7 mm (0.2 - 0.28 in)	5 - 7 mm (0.2 - 0.28 in)
Driver Pulley Size	250 mm (9.84 in)	225 mm (8.86 in)
Driven Pulley Size	130 mm (5.12 in)	130 mm (5.12 in)
Cutting Height Range	25 mm (0.98 in) to 97 mm (3.82 in) in 13 mm (0.50 in) increments	25 mm (0.98 in) to 97 mm (3.82 in) in 13 mm (0.50 in) increments

## WARRANTY

IMPLEMENT WARRANTY .....	71
--------------------------	----



## **IMPLEMENT WARRANTY**

A statement explaining the terms and conditions of the warranty coverage that applies to your implement is available by visiting [Igniteattachments.com](http://Igniteattachments.com).



## ALPHABETICAL INDEX

ASSEMBLING THE THREE-POINT FINISH MOWER .....	19
ATTACHMENT SIGNS (DECALS) .....	16
BLADE SPINDLE .....	61
BLADE .....	57
DAILY INSPECTION .....	22
FEATURES AND ACCESSORIES .....	7
FIRE PREVENTION .....	13
GEARBOX .....	58
IMPLEMENT IDENTIFICATION .....	6
IMPLEMENT STORAGE AND RETURN TO SERVICE .....	63
IMPLEMENT WARRANTY .....	71
LIFTING THE IMPLEMENT .....	41
LUBRICATING THE IMPLEMENT .....	54
MAINTENANCE SAFETY .....	45
MANUFACTURER .....	5
MOWER SPECIFICATIONS .....	67
OPERATING PROCEDURE WITH COMPACT TRACTOR .....	23
OPERATOR SAFETY WARNINGS .....	1
PUBLICATIONS AND TRAINING RESOURCES .....	15
REGULAR MAINTENANCE ITEMS .....	49
SAFETY INSTRUCTIONS .....	11
SERIAL NUMBER LOCATION .....	5
SERVICE SCHEDULE .....	48
TRANSPORTING THE IMPLEMENT AND MACHINE ON A TRAILER .....	42
TRANSPORTING THE IMPLEMENT ON A TRAILER .....	41
TROUBLESHOOTING .....	47





## Reference Information

Product Serial Number:

Engine Serial Number:

Dealer Information:



**WARNING:** Cancer and Reproductive Harm. This product can expose you to chemicals including lead and lead compounds, mineral oils, and phthalates which are known to the State of California to cause cancer and birth defects or other reproductive harm. For more information go to [www.P65Warnings.ca.gov](http://www.P65Warnings.ca.gov).