

OPERATOR'S SAFETY AND SERVICE MANUAL



MK8-75

This manual covers the following serial number and higher for each model listed:

MK8-75.....1780000



RIDE ON TROWELS

MBW, Inc.
250 Hartford Rd · PO Box 440
Slinger, WI 53086-0440
Phone: (262) 644-5234
Fax: (262) 644-5169
E-mail: mbw@mbw.com
Website: www.mbw.com

MBW (UK) Ltd.
Units 2 & 3 Cochrane Street
Bolton BL3 6BN, England
Phone: 01204 387784
Fax: 01204 387797

L18872 / 12.23.F
© MBW, Inc. 2023
Printed in the USA

Table of Contents

INTRODUCTION.....	5
CE DECLARATION OF CONFORMITY.....	7
1. GENERAL INFORMATION	8
1.1. GLOBAL ASPECTS OF SECURITY.....	9
1.2. SAFETY SIGNS (PICTOGRAMS ON THE MACHINE).....	10
1.3. SYMBOLS AND GLOSSARY.....	11
1.4. SPARE PARTS ORDER	12
1.5. REVIEW OF THE MANUAL.....	12
1.6. GENERAL TERMS AND CONDITIONS OF WARRANTY	13
2. MACHINE CHARACTERISTICS.....	14
2.1. IDENTIFICATION DATA OF THE MACHINE.....	15
2.2. INTENDED USE	15
2.3. PROHIBITED USE.....	15
2.4. TECHNICAL CHARACTERISTICS AND SIZE / NOISE / VIBRATIONS/ NON IONIZING RADIATION.....	16
2.5. OPERATOR POSITIONS/ LAYOUT/ OPERATION AND MAINTENANCE AREA.....	17
2.6. GENERAL DESCRIPTION	17
2.7. SAFETY DEVICES	18
2.8. INFORMATION ON RESIDUAL RISKS	19
3. TRANSPORT AND LIFTING.....	25
3.1. PACKING AND UNPACKING.....	26
3.2. LIFTING AND HANDLING	26
3.3. TRANSPORT	29
3.4. CHECK FOR POSSIBLE DAMAGE.....	29
3.5. STORAGE	29
4. MACHINE INSTALLATION	30
4.1. INSTALLATION.....	31
4.2. INITIAL CHECKS.....	32
4.3. PRELIMINARY STARTUP OPERATIONS	32
4.4. ENVIRONMENTAL CONDITIONS.....	34
4.5. STARTING THE WORK CYCLE.....	34
4.6. TROWEL STEERING.....	35
4.7. TROWEL STOP.....	35
4.8. RESTARTING THE TROWEL	35
5 TROWEL USAGE.....	36
5.1. SAFETY WARNINGS.....	37
5.2. SURFACE PREPARATION	37

5.3	TROWELING STAGE.....	37
5.4	FINISHING STAGE	37
5.5	LAYOUT OF CONTROLS.....	39
6	MAINTENANCE AND REPAIR.....	40
6.1	SCHEDULED MAINTENANCE.....	41
6.2	ROUTINE AND ADDITIONAL MAINTENANCE.....	46
6.3	NOTES ON DISMANTLING	48
6.4	TROUBLESHOOTING.....	49
6.5	PARTS LIST	52
6.6	WARRANTY	75

MBW, Incorporated (MBW) thanks you for purchasing one of its products and invites you to read this manual.

This manual includes instructions for use, maintenance rules and spare parts list for the **MK8- 75** trowel.

Inside you will find all the information necessary for the correct use of the purchased trowel; please carefully follow the instructions contained in the manual and read it in its entirety to better know the trowel and avoid running into problems caused by improper use.

According to accident prevention regulations, operators must be provided with all necessary personal protection equipment (P.P.E.) for their own safety (safety shoes, safety helmet, gloves, ear protectors, etc.).

Please keep the manual in a suitable place to keep it intact.

The contents of this manual may be modified without notice or further obligations in order to include changes and improvements to the units already provided.

The reproduction or translation of any part of this manual is prohibited without written notice and authorization by **MBW**.



WARNING



CALIFORNIA PROPOSITION 65 WARNING

Engine exhaust and some of its constituents and dust produced during the use of this product contain chemicals known in the state of California to cause cancer, birth defects, and other reproductive harm.

For more information go to **www.P65Warnings.ca.gov**

No part of this publication may be reproduced, stored in a retrieval system or transmitted in any form or by any means to third parties, without the prior written consent of the Manufacturer.

INTRODUCTION



The operation and maintenance manual is an integral part of the machine: it is necessary to keep it intact and in a safe place during the entire life of the machine, even in the case of switching to another user.

The MACHINE must be used in accordance with what is specified in this manual: it is recommended, therefore, to read it carefully before operating it, leaving out nothing from what is written and paying particular attention to text boxes.

This manual has been created, in reference to the provisions of the machinery directive 2006/42/EC as amended, with the purpose of

providing the user with a general knowledge of the machine and the information for:

- Correct awareness of operators regarding SAFETY issues.
- The intended use of the MACHINE, the characteristics of the user and the residual risks present.
- The handling, installation, use and maintenance of the machine safely.
- The safe demolition of the machine and its disposal in accordance with applicable regulations to protect the workers' health and the environment.

Compliance with the rules and recommendations contained in the manual, provide safe use and appropriate operation.

CE DECLARATION OF CONFORMITY
(DIRECTIVE 2006/42/EC - Annex IIA)
(written in the original language)

Company name and address of the manufacturer of the machine:

BARIKELL S.r.l.

Via Razzaboni, 118 41122 Modena (Italy) – Tel. +39 059 31.11.78 – email info@barikell.it

Name and address of the company authorized to compile the technical file: **SEMPREANORMA S.r.l.**

Via Turrini, 17 40012 Calderara di Reno Bologna (Italy) – Tel:+39 051.75.52.05

in the person of Pasquale Posa

It is hereby declared that the machine: MK8-75 trowel

Serial Number:

Year of Construction: **2018**

Briefly described below:

The double rotating MK8-75 trowel with operator on board has been designed and built for troweling of concrete and asphalt floors of warehouses, parking lots, cycle paths, parking areas, side-walks.

It complies with Directive 2006/42/EC, directives 2014/30/EU (EMC) and 2014/35/EU (low voltage) as well as the laws that transpose them.

It is also in compliance with the following harmonised standards:

- **UNI EN 12100:2010;**
- **UNI EN ISO 13849-1:2016;**
- **CEI EN 60204-1:2016;**
- **ISO 13105-2:2014.**

Modena,

Sincerely

Luca Zivieri

(Legal Representative of Barikell Srl)

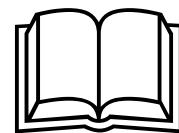

CHAPTER **1**

1. GENERAL INFORMATION

- 1.1 Global aspects of security
- 1.2 Safety signs
- 1.3 Symbols and glossary
- 1.4 Spare parts order
- 1.5 Review of the manual
- 1.6 General terms and conditions of warranty

1.1. GLOBAL ASPECTS OF SECURITY

Compliance with the rules and recommendations contained in this publication provide safe use and appropriate operation of the machine.



- 1) The best performance and long life of the machine will be obtained from its appropriate use. Scrupulous observation of the instructions contained in this manual becomes, therefore, necessary;
- 2) Any spare parts request must include the model type and serial number provided in the list of spare parts or applied on components' plates;
- 3) Installation of the machine must be carried out in compliance with the safety regulations in force;
- 4) Do not remove or tamper with the protections and safety devices, check their effectiveness periodically;
- 5) Strictly observe the instructions mentioned by hazard symbols (pictograms) and maintain readability of the message;
- 6) Operation and maintenance must be performed by qualified personnel, trained and enabled to perform the tasks foreseen. Operation procedures and responsibilities of operators must be clearly defined to ensure safe and proper use and maintenance;
- 7) Before any maintenance or adjustment operation you must select and block all power sources, making sure to avoid unexpected starts;
- 8) If the machine maintenance is not performed in accordance with instructions provided, is carried out with non-original spare parts or without written permission of the company that performed maintenance of the used

machine, or otherwise in such a way as to compromise its integrity or modify its characteristics relieves the company from any responsibility regarding the safety of persons and the faulty operation of the machine.

- **The user shall be required to comply with periodic maintenance warning indicated in Chapter 6;**
- **The user shall be required to comply with the qualifications of the relevant personnel:**

OPERATOR / MAINTENANCE TECHNICIAN:



Carries out the tasks necessary for the basic functioning of the machine: execution of the work cycle, implementation of operator commands, other operations closely linked to normal production, any cleaning and inspection operation performed on a daily basis, enforcement of ordinary maintenance operations (see Chapter 6). Works only with enabled safety functions.

MAINTENANCE TECHNICIAN SPECIALIST

(RESELLER):



Involved in all operating conditions and at all protection levels. Makes extraordinary operations that cannot be run by the user (see Chapter 6 regarding maintenance).

1.2. SAFETY SIGNS (PICTOGRAMS ON THE MACHINE)



It is absolutely necessary to recognize the meaning of the signs present on the machine and keep their message readable.

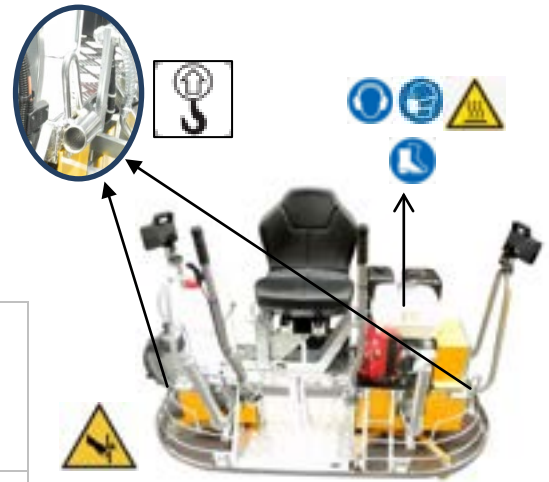

GENERIC HAZARD SIGN "OBLIGATION TO READ THE MANUAL"	
INSTRUCTION SIGN "USE LIFTING HOOK"	
INSTRUCTION SIGN "FIX THE LOAD TO THE TRANSPORT MEANS" (if applicable)	
HAZARD SIGN "DANGER OF MOVING PARTS"	
HAZARD SIGN "DANGER OF HIGH TEMPERATURES"	
HAZARD SIGN "DANGER OF CUTTING AND SECTIONING"	
OBLIGATION SIGN "MANDATORY USE OF EAR PROTECTORS"	
OBLIGATION SIGN "OBLIGATION TO USE SAFETY SHOES"	
OBLIGATION SIGN "OBLIGATION TO USE AIRWAY PROTECTION"	

In case of damage replace them immediately preventing the use of the machine. It bears the

following safety signs (pictograms). Residual risks are summarized in Chapter 2 Par. 2.8.

CAUTION!

DO NOT REMOVE, DAMAGE OR MODIFY THE PICTOGRAMS ON THE MACHINE. BEFORE EACH WORK SHIFT CHECK THEIR PRESENCE AND GOOD CONDITION. IN CASE OF THEIR DETERIORATION, REPLACE THEM, PREVENTING THE USE OF THE MACHINE UNTIL THE REPLACEMENT HAS TAKEN PLACE.

1.3. SYMBOLS AND GLOSSARY



- **HAZARD:** A potential source of injury or damage to health;
- **HAZARDOUS AREA:** Any area within and/or in the vicinity of the machine where the presence of a person constitutes a risk to the health and safety of the said person;
- **EXPOSED PERSON:** Any person wholly or partially located in a hazardous area;
- **OPERATOR:** The person or persons tasked with installing, operating, adjusting, cleaning, repairing and moving a machine or performing its maintenance;
- **RISK:** Combination of likelihood and severity of an injury or harm to health that can arise in a dangerous situation;
- **INTENDED USE:** the use of the machine in accordance with the information provided in the Instructions for Use (Par. 2.2);
- **ANY REASONABLY FORESEEABLE MISUSE:** Machine use other than that indicated in the instructions for use, but that may derive from the easily predictable human behaviour;
- **HUMAN-MACHINE INTERACTION:** Any situation in which an operator has to interact with the machine in any of the operational phases at any moment in the machine's life;
- **OPERATOR QUALIFICATION:** Minimum level of skills that the operator must possess in order to carry out the described operation;
- **NUMBER OF OPERATORS:** Appropriate number of operators to optimally carry out the operation described and deriving from a careful analysis conducted by the "Manufacturer", meanwhile the use of

a different number of workers could prevent the desired result from being achieved or endanger the safety of the personnel involved;

- **MACHINE STATUS** means:
 - The mode of operation: automatic gear, manual operation, shutdown.
 - The condition of the safety devices on the machine: with or without guards, emergency shut-down pressed, type of selection of energy sources, etc.;
- **GUARD:** Piece of the machine used specifically for protection through a material barrier;
- **SAFE SHUT-DOWN:** Condition of shut-down obtained with safety measures which avoid unexpected start-ups of hazardous parts;
- **RESIDUAL RISK:** Risk that has not been possible to eliminate or sufficiently reduce through the design, against which the protections are not (or are not totally) effective;
- The manual gives information of its existence and instructions/warnings to avoid it;
- **SAFETY COMPONENT:** Means a component used for ensuring a safety function and whose breakdown or malfunction affects the safety and/or health of exposed persons (eg. lifting device; fixed, mobile, adjustable guard, etc., electrical, electronic, optical, pneumatic, hydraulic device, guard interlocking, etc.).
- **ABBREVIATIONS:**
 - CHAP. = Chapter
 - PAR. = Paragraph
 - PAG. = Page
 - FIG. = Figure
 - TAB. = Table
 - P.P.E. = Personal protective equipment
 - CFR = see

The present publication uses symbols with the following meaning:

!IMPORTANT: Indicates important technical information which must not be overlooked.

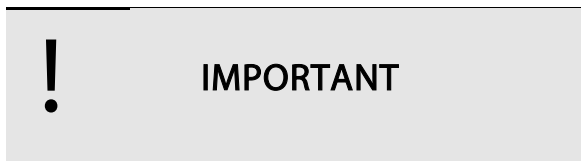

!CAUTION: Indicates the need to adopt specific precautions for not putting at risk the health and safety of persons and not cause economic damage.



Generic warning sign that defines the obligation to read the manual:



1.4. SPARE PARTS ORDER

The order of replacement parts must clearly state the data necessary for their identification

and the data shown on the machine identification plate.

E.g.:

- Machine model
- Type
- Serial Number
- Year of construction
- Description
- Requested quantity
- Shipping method
- Address, telephone number and name of the applicant

For any additional information please contact the manufacturer.

1.5. REVIEW OF THE MANUAL

We recommend to constantly update this manual, integrating it with the comments received from the maintenance technician. It is appropriate to clearly insert any annotations or comments.

1.6. GENERAL TERMS AND CONDITIONS OF WARRANTY

- 1) The new machines are out of warranty with regard to the structure and use of suitable materials, subject to the following conditions:
- 2) The warranty is valid for a period of twelve (12) months.
- 3) The manufacturer undertakes to repair or replace at its discretion any parts or groups which have proved to be defective.
- 4) Repaired or replaced parts are covered under the same warranty as the original parts, expiring 12 months after the installation of these parts.
- 5) The manufacturer sets an adequate time period to carry out the necessary works and to deliver the spare parts.
- 6) All transport costs of the parts intended for replacement under this warranty must be borne by the purchaser.
- 7) Repairs and operations carried out during the warranty period by unauthorized personnel will void any rights to warranty claims.
- 8) During the warranty period, the replaced parts become property of the manufacturer.
- 9) Components not manufactured by us are subject to the warranty conditions of the original manufacturers. Any claims will be transferred to the purchaser.
- 10) This warranty only applies to the original purchaser. Our responsibility on the warranty is void if you are experiencing these situations:
 - a. The original owner transfers the ownership of the machine,
 - b. If changes were made to the machine,
 - c. If you have added to the machine parts and devices that have not been manufactured by us.
- 11) No responsibility is assumed for any damage caused to the floor due to malfunctioning or stoppage of the trowel during operation.
- 12) The warranty does not include damage caused by excessive stress such as continuous use of the machine after.
- 13) Detecting an anomaly caused by improper use or maintenance, use of inadequate operating materials and the failure to observe the operating instructions. The same applies to damage caused by normal wear.
- 14) As regards engine warranty, this is subject to the conditions of the original manufacturers.
- 15) The established warranty conditions are binding for all sellers of MBW. Any other agreements will be considered valid only after written confirmation by MBW.
- 16) Labor and processes necessary for the replacement of defective parts under warranty are charged to the Customer.

IMPORTANT!

If you consider it necessary to use the warranty, please indicate the following information:

- Model and serial number of the machine and of its engine
- Date of purchase
- Detailed description of the issue.

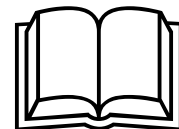

CHAPTER **2**

2. MACHINE CHARACTERISTICS

- 2.1 Identification data of the machine
 - 2.2 Intended use
 - 2.3 Prohibited use
- 2.4 Technical characteristics and size / noise / vibrations / non ionizing radiation
 - 2.5 Operator positions / layout / operation and maintenance area
 - 2.6 General description
 - 2.7 Safety devices
- 2.8 Information on residual risks



CAUTION

Do not remove, damage or modify the machine identification information on the machine. In case the data become unreadable immediately contact the manufacturer.

2.1. IDENTIFICATION DATA OF THE MACHINE

In order to ensure proper identification of the machine, please refer to the serial number stamped on the invoice and the data imprinted on the manufacturer's plate bearing the CE marking symbol attesting to its conformity to the directives applicable.

The plate includes the following required information:



Figure 2.1



- Manufacturer's name and address (1)
- CE Marking (2)
- Year of construction (3)
- Type designation (4)
- Serial number (5)
- Motorization number (6)
- Motorization power (\dot{r}) (7)
- Mass in kg (8)

2.2. INTENDED USE

The double trowel machine "MK8-75" is designed and manufactured to perform finishing (troweling) of concrete and asphalt floors of sheds, car parks, cycle paths, parking areas, sidewalks, etc. To make this kind of the machining operations the machine is equipped with two rotors: One of them is rotates right and the other rotates left.

The engine and the operator's seat are fixed to a frame connected to both rotors.

The adjustable seat is located at a very low height which allows you to create different advantageous conditions for processing:

- A higher flatness of the floor surface (thanks to a lowering of the machine's centre of gravity).
- An excellent view of the inspection of the processing.

All steering parts (levers, joints, drive shaft, reducers) are protected by a tunnel whose purpose is to prevent the accumulation over time of cement deposits that can cause a more rapid damage to mechanical components.

The machine may only be used by professional operators.

2.3. PROHIBITED USE

Any use other than what is explicitly stated in PAR. (§ 2.2) and implemented differently or contrary to what is stated in this publication represents a possible **misuse**. The manufacturer accepts no responsibility resulting from improper use which may lead to personal injury and any system malfunctions.

IMPROPER USE IS CONSTITUTED BY THE FOLLOWING 'PROHIBITED' ACTIVITIES:

- THE MACHINE IS USED IN AN EXPLOSIVE ENVIRONMENT (THIS FACILITY IS NOT IN COMPLIANCE WITH ATEX 2014/34/EU).
- OTHER SYSTEMS AND/OR EQUIPMENT ARE ADDED EVEN IF THEY ARE NOT INCLUDED BY THE MANUFACTURER IN THE EXECUTIVE PROJECT.
- THE MACHINE IS ATTACHED TO POWER SOURCES OTHER THAN THOSE SPECIFIED BY THE MANUFACTURER.

- THE MACHINE IS USED FOR A PURPOSE OTHER THAN THAT INTENDED AND SHOWN IIN THIS PUBLICATION.
- THE MACHINE IS USED INDOORS.
- THE MACHINE IS NOT USED FLUSH WITH THE WALL.
- INFRINGE THE MAINTENANCE RULES DESCRIBED HEREIN.
- THE MACHINE IS USED IN AIR CONTAINING SMOKE, DUST, WATER VAPOR OR SOLVENT.

- EQUIPMENT OTHER THAN THAT EXPRESSLY DESIGNATED BY THE MANUFACTURER IS USED.
- THE MACHINE IS USED BY A NUMBER OF OPERATORS OTHER THAN THAT EXPRESSLY PROVIDED BY THE MANUFACTURER (see PAR. 2.5 of this publication) DIRECTIONS CONCERNING OPERATOR LOCATIONS ARE DISREGARDED.

2.4. TECHNICAL CHARACTERISTICS AND SIZE / NOISE / VIBRATIONS/ NON IONIZING RADIATION

Description	Unit of measurement	Cod 3205	Cod 3208	Cod 3206	Cod 3207	Cod 3210
Dimensions:	[mm]	1550 x 800 x 970	1550 x 800 x 970	1550 x 800 x 970	1550 x 800 x 970	1550 x 800 x 970
Package sizes	[mm]	1600 x 900 x 900	1600 x 900 x 900	1600 x 900 x 900	1600 x 900 x 900	1600 x 900 x 900
Operating weight	[kg]	178	180	192	194	198
Weight on delivery	[kg]	220	220	240	240	240
Engine	-	Honda	Subaru-Robin	Honda	Robin	B & S
Installed power:	kw	13	13.5	13	14	18
Starting:		Manual	Manual	Electric	Electric	Electric
Cooling:	-	Air	Air	Air	Air	Air
Power supply:	-	Petrol	Petrol	Petrol	Petrol	Petrol
Petrol tank capacity:	lt	11	11	11	11	11
Max engine rotation speed:	[rpm]	3600	3600	3600	3600	3600
Min - max blade rotation speed:	[rpm]	70-130	70-130	70-130	70-130	70-130
Rotor diameter:	[mm]	750	750	750	750	750
Number of blades	-	8	8	8	8	8
Max. forward speed	[m/min]	90	90	90	90	90
Root mean square acceleration value:	m/s ²	0,8 - 1	0,8 - 1	0,8 - 1	0,8 - 1	0,8 - 1
NOISE AND VIBRATIONS						
Residual noise values while machine is at work						
Sound pressure level LpA	dbA	91.6				
Sound power level LwA	dbA	106.8				
Vibration values while machine is at work						
Hand-arm system: Left handle value – with higher exposure	A _{hv sum} [m/s ²]	< 2.5				
Total body system	A _{wv max} [m/s ²]	1.1				
NON IONIZING RADIATION						
The machine <u>does not</u> emit non ionizing radiation potentially dangerous for operators						

**2.5. OPERATOR POSITIONS/
LAYOUT/ OPERATION AND
MAINTENANCE AREA**



Tier 1 OPERATOR POSITION

CAUTION



Only one operator is required to operate the machine. Tasks and positions are detailed in PAR. (§) 2.5 of this publication. Failure to follow the indications above represents a possible MISUSE and relieves the manufacturer from any liability arising from incorrect use/misuse.

The machine must be operated by one single operator. The latter operates the machine during the normal work cycle.

While using the machine the operator is in a sitting position. He/she moves the machine controls consisting of two steering levers positioned on the left and right side of the operator and the accelerator lever. All controls are operated from a sitting position.

The machine can be started with the operator seated only (a safety micro switch enables starting only if the operator is seated). The adjustments pertaining to processing (blade tilting adjustment) are performed with the operator in the working position.

The operator position (figure below) is also an inspection location from where it is possible to supervise the proper conduct of the work cycle. The 1 tier operator is responsible for carrying out cleaning after use.

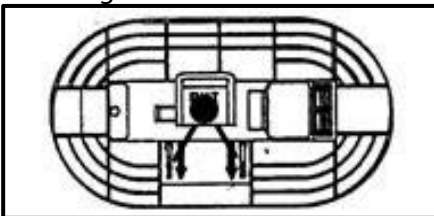

2 Tier OPERATOR (RESELLER- SPECIALIZED DEALER)

The reseller (expert maintenance technician) performs maintenance and repair tasks designed by the manufacturer (compare chapter 6 of this publication).

He/she always operates with the machine stopped and power disconnected unless expressly provided otherwise.



IMPORTANT!

To define the maintenance area you need to consider about 1.5 m on all sides of the machine (fig 2.3 on next page).

2.6. GENERAL DESCRIPTION

The double trowel machine "MK8-75" is designed and manufactured to perform finishing (troweling) of concrete and asphalt floors of sheds, car parks, cycle paths, parking areas, sidewalks, etc

The power supply is provided by an internal combustion engine running on unleaded petrol.

The following table lists the functional groups of the machine.

FUNCTIONAL GROUPS MK8-75 TROWELING MACHINE	
1	RIGHT ROTOR
2	LEFT ROTOR
3	BLADE TILT ADJUSTMENT LEVER ON THE RIGHT
4	BLADE TILT ADJUSTMENT LEVER ON THE LEFT
5	THROTTLE
6	RIGHT-SIDE CONTROL BAR
7	LEFT-SIDE CONTROL BAR
8	FUEL TANK
9	SEAT
10	ENGINE
11	WATER TANK
12	FEATHER EDGE DISCS
13	SAFETY DEVICES (SEE RELEVANT PARAGRAPH)

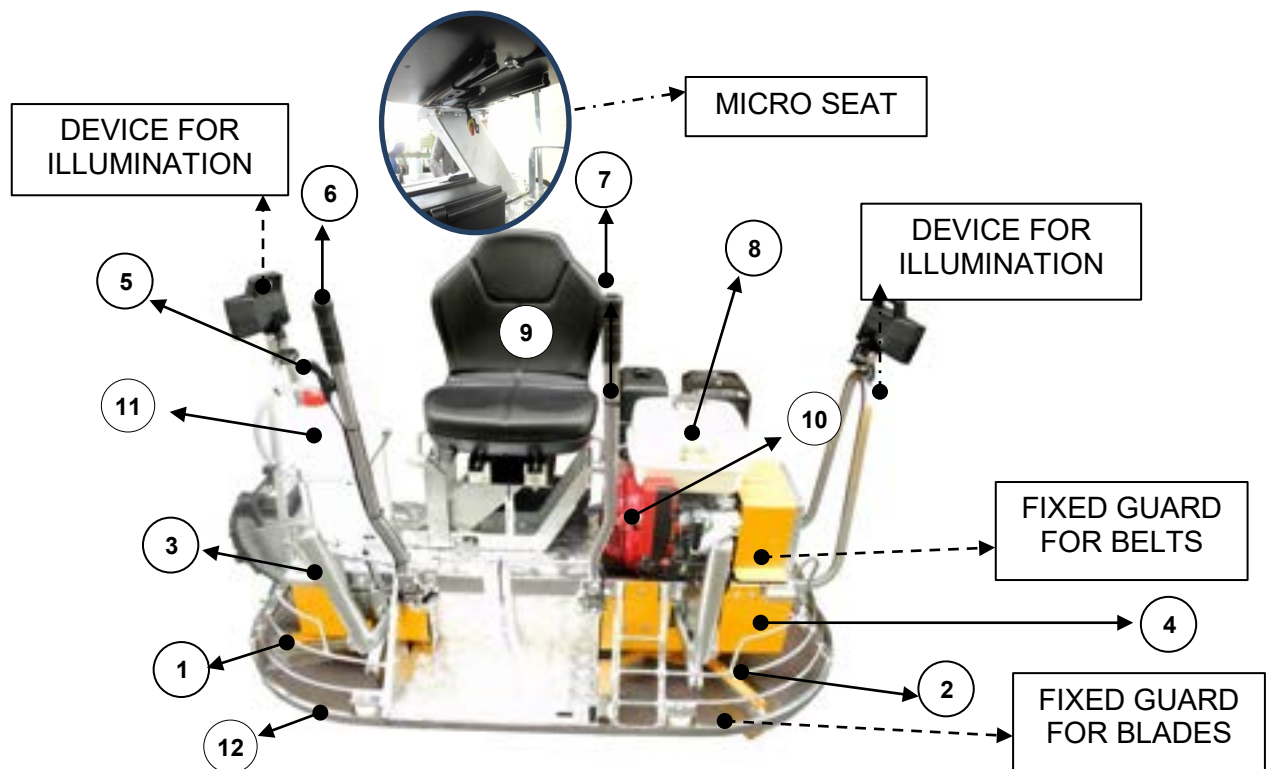

Figure 2.2

TYPE OF POWER SUPPLY

IMPORTANT!

For more detailed information about engine characteristics refer to the manual of the component that is an integral part of this publication.

The machine must be powered following the instructions provided by MBW.

For safe operation read the following precautions carefully:

- The power supply of the device is provided by an air-cooled internal combustion engine running on unleaded petrol.
- The engines fitted to the machine can be of different types (see technical characteristics, p. 15).
- Start the engine by turning the ignition key in the appropriate panel.

- The pull-up starting is also envisaged.

The fuel consists of unleaded petrol that reaches the carburetor from the tank after having been filtered.

Blade rotation in the troweling machine is transmitted by the engine to a pair of centrifugal clutches, connected with two trapezoidal belts to rotor gearboxes.

2.7. SAFETY DEVICES

Security measures included are represented by (see figure: 2.2):

- 1) Seat micro-switch that prevents starting of the machine until the operator is seated in the working position
- 2) Fixed guard of timing belts
- 3) Fixed guards for safeguarding of the blades
- 4) Illumination devices

2.8. INFORMATION ON RESIDUAL RISKS

Despite the application, at the design stage, of the rules contained in the safety requirements (RESS) as required by current legislation and despite the adoption of safety measures, there is a residual risk that cannot be eliminated. Residual risks are appropriately reported through the application of specific **SAFETY SIGNS** called **PICTOGRAMS** located at the dangerous areas.

The pictograms have different meanings, in particular:

- **HAZARD SIGN: BLACK AND YELLOW OF TRIANGULAR FORM**
- **PROHIBITION SIGNS: WHITE AND RED OF CIRCULAR FORM**
- **OBLIGATION SIGNS: BLUE AND WHITE**

RESIDUAL RISKS ARE SUMMARIZED IN THE TABLES SHOWN IN THE FOLLOWING PAGES (FROM P. 19 TO P. 23).

MAC Risk Assessment

Revision 06 - 2013

Doc. no. 17 | 17.20

Residual Risks



RISKS	Reference Signs			SI	Residual Risks
	Danger	Prohibition	IPD		
MECHANICAL + PNEUMATIC					
Inadequate spaces				<input type="checkbox"/>	It is forbidden to start the machine without connecting the trowel disc to the blades as indicated in the user manual .
Caught, entrapped, dragged				<input checked="" type="checkbox"/>	There is a risk of entanglement, prohibited use of loose or fluttering clothing (are banned scarves, ties, or non-adherent clothing).
Crushing of upper limbs				<input checked="" type="checkbox"/>	In case you need to replace the trowel disc, you must use protective gloves as some components (blades), if worn, could be sharp.
Crushing of lower limbs				<input checked="" type="checkbox"/>	
Shearing				<input checked="" type="checkbox"/>	
Abrasions, cuts, punctures and/or perforations			 	<input checked="" type="checkbox"/>	In case it is necessary to lift the machine (operation allowed only through the four lifting hooks supplied), the trowel discs must first be removed as they could inadvertently disengage.
Collisions, impacts and/or compressions with materials and equipment			 	<input checked="" type="checkbox"/>	Pay attention during the horizontal movement of the machine using the trolley (optional): when the trolley is detached from the trowel machine, the handle of the trolley must be firmly held in order to reduce the risk of collision with it.
Slip, stumble and fall				<input checked="" type="checkbox"/>	
Collisions and/or impacts with transport means in transit			 	<input type="checkbox"/>	It is mandatory to use the individual protection devices required for the employee to the trowel (safety shoes, gloves, mask).
Falling objects				<input type="checkbox"/>	Before starting maintenance activities, carefully read the instructions in the instruction manual.
Projection of materials		 	 	<input checked="" type="checkbox"/>	It is forbidden to circumvent the implemented security.
Injuries deriving from poor lighting of spaces and/or working stations				<input type="checkbox"/>	
Projection of fluids at high pressure		 		<input type="checkbox"/>	

MAC Risk Assessment

Revision 06 - 2013

Doc. no. 17 | 17.21

Residual Risks



RISKS	Reference Signs			SI	Residual Risks
	Danger	Prohibition	IPD		
THERMAL					
Presence of heated surfaces, heat and flames				<input checked="" type="checkbox"/>	It is necessary to wait for the cooling of the engine and muffler surfaces before conducting maintenance activities. Use heat resistant gloves.
Scalds/burns caused by contacts with heated surfaces	 	 	 	<input type="checkbox"/>	
Presence of cold surface		 	 	<input type="checkbox"/>	
NOISE					
Localized noise		 		<input checked="" type="checkbox"/>	Obligation to use ear protectors.
Background noise		 		<input type="checkbox"/>	
Injuries caused by interferences in verbal communication				<input type="checkbox"/>	
VIBRATIONS					
Vibrations transmitted to the whole body				<input checked="" type="checkbox"/>	Obligation to use anti-vibration gloves. Limit exposure times.
Vibrations transmitted to the complex hand-arm				<input type="checkbox"/>	

MAC Risk Assessment

Revision 06 - 2013

Doc. no. 17 | 17.22

Residual Risks



RISKS	Reference Signs			SI	Residual Risks
	Danger	Prohibition	IPD		
RADIATION					
Ionizing radiation				<input type="checkbox"/>	Not applicable.
Non ionizing radiation, heat, light				<input type="checkbox"/>	
Laser equipment				<input type="checkbox"/>	
Exposure to Infrared and Ultraviolet Rays				<input type="checkbox"/>	
DIRECT AND INDIRECT ELECTRICAL					
Electrocution caused by direct and indirect contacts				<input type="checkbox"/>	Negligible.
Electrostatic phenomena				<input type="checkbox"/>	
Electric arcs				<input type="checkbox"/>	
Injuries caused by failures in power supply and/or in the control system				<input type="checkbox"/>	
Exposure to electromagnetic fields				<input type="checkbox"/>	







MAC Risk Assessment

Revision 06 - 2013

Doc. no. 17 | 17.23

Residual Risks



RISKS	Reference Signs			SI	Residual Risks
	Danger	Prohibition	IPD		
FIRE AND EXPLOSION					
Fire and explosion	 	 		<input checked="" type="checkbox"/>	The filling operations of the petrol tank must be carried out in a well-ventilated area away from possible sources of heat or flames.
Presence of explosive atmospheres		 		<input type="checkbox"/>	
PHYSICAL WORKING LOAD					
Manual handling of loads				<input type="checkbox"/>	Not applicable.
Repeated actions of upper limbs				<input type="checkbox"/>	
Incorrect positions and/or excessive physical efforts				<input type="checkbox"/>	

MAC Risk Assessment

Revision 06 - 2013

Doc. no. 17 | 17.24

Residual Risks



RISKS	Reference Signs			SI	Residual Risks
	Danger	Prohibition	IPD		
CHEMICAL + BIOLOGICAL					
Injuries caused by the presence and use of stored chemical products				<input type="checkbox"/>	<p>The trowel activities must be carried out in environments with adequate ventilation.</p> <p>The use of personal protective equipment for the protection of the airways is recommended.</p>
Splashes				<input type="checkbox"/>	
Ingestion				<input type="checkbox"/>	
Inhalation				<input checked="" type="checkbox"/>	
Diseases caused by the presence of fluids, gases, fogs, fumes and powders				<input type="checkbox"/>	
Direct contacts				<input type="checkbox"/>	
Exposure to carcinogenic and mutagenic agents				<input type="checkbox"/>	
Exposure to asbestos				<input type="checkbox"/>	
Deliberated use of biological agents				<input type="checkbox"/>	
Accidental presence of biological agents				<input type="checkbox"/>	
Handling of potentially infected waste				<input type="checkbox"/>	

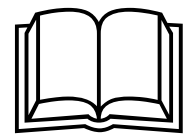

CHAPTER **3**

3. TRANSPORT AND LIFTING

- 3.1 Packing and unpacking
- 3.2 Lifting and handling
- 3.3 Transport
- 3.4 Check for possible damage
- 3.5 Storage

3.1 PACKING AND UNPACKING

The double "MK8-75" trowel remains substantially intact for packaging and transport operations.

The only parts that are removed are respectively:

- The seat should be removed from the rear area by sliding it on the positioning guides after loosening the 4 fixing bolts;
- The steering levers that are lowered (fig 3.1). See the installation section (PAR. 4.1) for data relating to the repositioning of these levers;
- The micro-switch under the seat is disconnected;
- The lamps are lowered and turned inwards by activating the handles (fig 3.1);
- The battery cable is disconnected;
- Before starting with packaging it is recommended to always replace the feather edge disc to the blades to protect them from any dents before insertion into the package following the procedure given in PAR. 6.2.3;
- **The package, unless otherwise agreed with the customer, consists of a cardboard case.** Normally the machine is directly inserted into the cardboard case, by moving it from the top (see PAR. 3.2). The cases are placed on special wooden pallets heat-treated for health and hygiene-related reasons.

The lifting of the case should be performed from the bottom through a means of sufficient capacity for the load to be lifted (approved for a mass greater than or equal to that to be lifted).

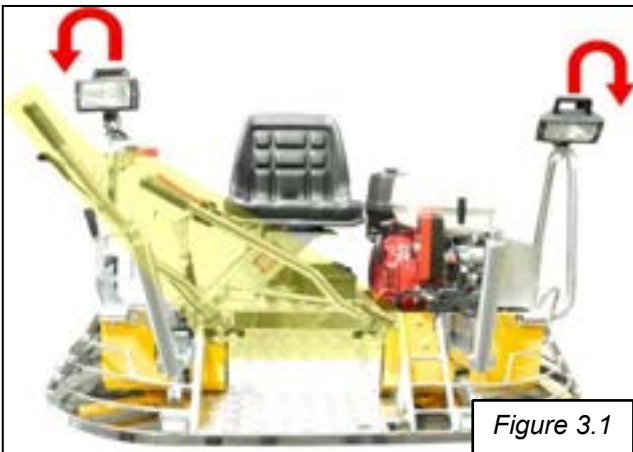

Figure 3.1

- The maximal weight of the packaged product is 220 kg as shown in the table of general specifications on p. 15.

CAUTION



Each element of waste must be collected and relocated in a special container according to the guidelines for the selective collection of waste; if released into the environment it can be a source of pollution and danger.

3.2 LIFTING AND HANDLING

The total weight of the machine is \leq 190 kg. The lifting must be performed from the top.

CAUTION



Slings /transport gear must take into account the shape and volume and the mass indicated on the label and/or on the machine specifications.

Make use of ropes or straps and lifting gear (crane or forklift truck) with a capacity greater than that to be lifted.

PACKAGED WEIGHT: MAX 220



Figure

CAUTION



For lifting at more than one meter from the ground remember to remove the feather edge disc before the lifting operation.

1. Secure all four straps to the four hooks on either end: 2 on the right and 2 on the left of the device at the top lifting hazard pictograms (fig. 3.3).

Use hooks provided with safety fasteners which do not allow rope slipping.

2. Use a lifting tool (crane or forklift) connecting the appropriate gear to

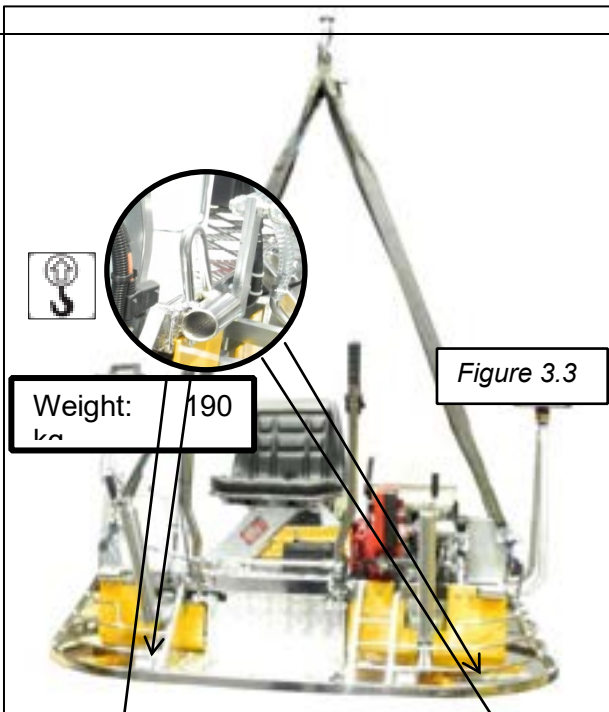

these straps, while slowly tensioning the ropes/straps.

3. The machine may be equipped with an optional hook (eyebolt) for lifting as shown in fig. 3.4. In this case the lifting is done by being anchored to this element in the only single central point as shown in Figure 3.4.
4. The lifting gear must be approved for lifting, without imbalance, a load with a capacity exceeding the total weight of the machine.
5. Lift the machine as close as possible to the ground and avoid oblique pulling.
6. Perform displacements and maneuvers with the help of one person on the ground responsible for the signs that will have to remain distant from the suspended load.



CAUTION



For lifting at more than one meter from the ground remember to remove the feather edge disc before the lifting operation (PAR. 6.2.3) to avoid any danger to persons or damage to property.

During the lifting and movement the entire area involved in the maneuvers should be accessible to authorized persons only.



Horizontal displacement

A handling trolley is provided along with the machine with the purpose to support the machine and handle it safely. The trolley is equipped with a handle with a final grip through which 4 wheels are mounted on the machine: 2 small and 2 big wheels that make the machine easily transportable by ground.

1. Insert the small wheel of the trolley by means of the handle on the cavity at the bottom of the machine (fig. 3.5, a).



2. Secure it with the appropriate lock (fig. 3.5, b).
3. Perform the operation on both sides of the machine.
4. The two large wheels (fig. 3.5, c) belonging to the handling device should be mounted using the handle of the trolley and attached to the machine frame.

CAUTION

- ! Pay particular attention to the task of removing the handling trolley of the machine because it tends to undergo a dangerous kickback that can cause its jolting creating dangerous situations for those involved in the operation. There is a residual risk of impact as indicated in the table of residual risks.

3.5 STORAGE

3.3 TRANSPORT

Depending on the country of destination transport can be made with different means. The diagram below represents the most commonly used solutions. In the case of transport by truck it is especially important to always check that the load does not protrude beyond the outline allowed by the highway code (height 4 m, width 2,5 m).

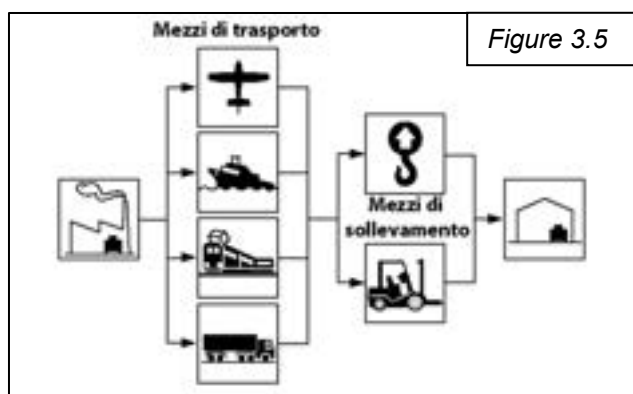

CAUTION

- For transport by truck (without case) position the blades horizontally by turning the adjustment handles. Transportation of the trowel with the blades tilted may damage the pallet lifters.

CAUTION

- In the event of road transport the load of vehicles shall be arranged in such a manner as to avoid its falling or dispersion, in order to neither decrease the visibility of the driver nor to prevent the free driving movements, nor to mask the lighting devices, visual signalling, recognition plates or hand signals (art.164 of the highway code) and in accordance with the requirements of Directive 2014/17/EU.

3.4 CHECK FOR POSSIBLE DAMAGE

Upon delivery of the machine the staff responsible should check for its completeness and any transportation damage. **Any faults must be reported immediately to the supplying company.**

CAUTION

- During unloading from transport means and placement of the machine, the maneuvering area is only accessible to authorized persons. Do not allow unauthorized personnel in the vicinity of the structure during the lifting operations. During the execution of these activities make use of the appropriate P.P.E. (personal protection equipment): accident prevention gloves & footwear.



In case the machine is not immediately installed, it is appropriate place it in an environment with characteristics equal to those of the environment of use, in particular:

- In case the storage exceeds one month, always interpose between the floor and the machine parts, wooden pallets or other material to avoid direct contact with the floor;
- Place the parts of the machine away from areas exposed to moisture or inclemency of the weather;
- Protect unpainted parts (blades) with anti-oxidant oil and fat-based products;

If you plan not to use the machine for a period longer than one month you must empty the fuel tank in order to avoid the formation of gum deposits and detach the battery cable (negative pole, see PAR. 4.1); if the machine is put in places where the temperature may fall below 0° C, empty the water tank.

CAUTION

- Never put the machine with full fuel tank in places where petrol fumes could come into contact with ignition sources (flames and/or sparks).

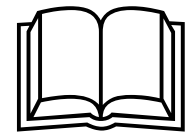

CHAPTER **4**

4. MACHINE INSTALLATION

- 4.1 Installation
- 4.2 Initial Checks
- 4.3 Preliminary startup operations
- 4.4 Environmental conditions
- 4.5 Starting the work cycle
 - 4.6 Trowel steering
 - 4.7 Trowel stop
- 4.8 Restarting the trowel

CAUTION



The environmental and operating conditions must not hinder access to the controls of the MACHINE. The machine's place of installation MUST be equipped with good lighting and must be free of shadows and glare that may annoy the operator. The minimum brightness level of the work area and the area for performing maintenance activities is 300 lux. For this purpose, the machine is equipped with two lateral 12 Volt lamps.



Machine installation and operations related to it must only be carried out by **qualified personnel of the user**.

- Always use protective shoes;
- Never place hands or other body parts under components which are raised or could be pulled on by gravity.
- Do not wear rings, watches, bracelets, or clothes that are too large and dangling during the assembly and/or maintenance operations;
- Do not perform actions outside their field of knowledge and responsibility.

THE SYSTEM IN QUESTION CANNOT OPERATE IN AN EXPLOSIVE ATMOSPHERE.

4.1 INSTALLATION

The trowel is delivered appropriately arranged in its packaging, with steering levers folded as shown in figure 3.1.

After unloading the machine from the means of transport using a forklift and following the completion of the unloading and unpacking procedures:

- Place the machine on the floor: remember to remove the feather edge discs for lifting at more than 1 m of height and put them back before placing the machine on the ground.
- Insert the seat disassembled before packing along the mounting rails on the support plate (fig. 4.1) and fasten it with 4 bolts (fig. 4.1, a and b). Tighten the nuts securely with the appropriate tool.

Figure 4.1



- Mount the steering levers following this procedure:
- Insert the central tie-rod joint into its housing (1), the side tie-rod joint (2) of the side lever, screw and tighten the nuts securely by means of the key 22.

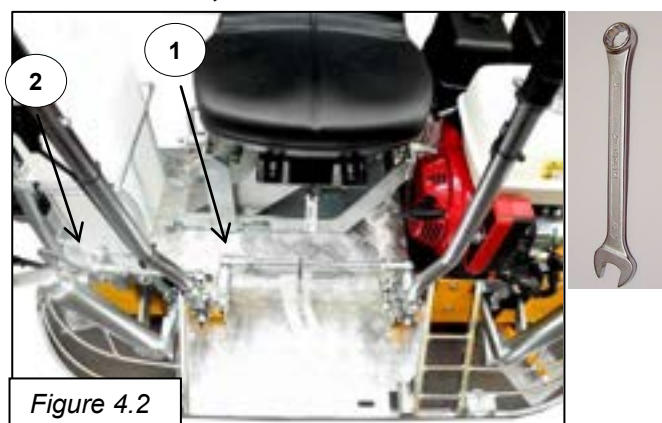

- Replace the lock of the tie-rods (fig. 4.3).

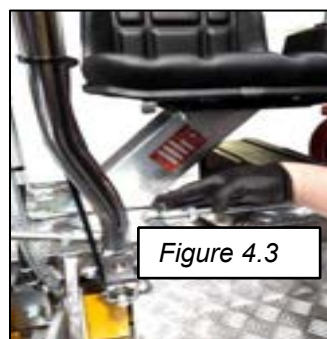

- **Connecting the battery cable:** remove the cover and fasten the relevant cable to the negative terminal of the battery (fig. 4.4) by tightening the clip with the appropriate tool (13 key).



CAUTION

- It is recommended to connect the battery cable correctly. Please refer to the manual of the manufacturer of the engine that is an integral part of this publication.

- Rotate upward the lighting devices.
- Connect the wire of the seat microswitch (fig. 4.5).



Figure

- Upon receipt check that the trowel arrives intact. Otherwise contact our dealer (see PAR. 3.5).

Water supply

The trowel is provided with a water delivery system consisting of a tank (1, fig. 4.6) placed on the right side of the machine.

The water supply (in some cases necessary for processing) is carried out by pressing the appropriate control located above the left control lever (2, fig. 4.6).

Special sprinkling nozzles positioned at the bottom of the machine channel water on the

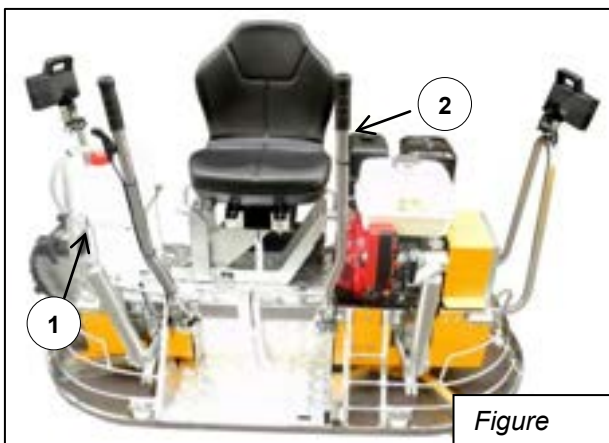

Figure

working surface.

4.2 INITIAL CHECKS

1. Check the oil level in the engine and, if necessary, top it up (par. 4.3.4);
2. Check the fuel level in the tank and, if necessary, arrange its filling (par.4.3.3);

CAUTION

- It is recommended to make sure that the petrol contains no water and not to use mixtures or diesel. Perform this operation in a well ventilated environment and away from possible sources of heat or flames. Make use of specific PPE (for airway protection) as shown in the residual risks table on page 20 of this publication.

3. Ensure that all guards are present, efficient and functional;
4. Adjust the position of the seat horizontally in order to obtain the best possible working position (section 4.3.);
5. Check that the inclination degree of blades is at least 1 cm. in order to have a greater control of the trowel upon starting. (For the adjustment see par. 5.4);
6. Make sure that the trowel is placed on an equal plane with a capacity greater than 300 kg/m² and that there is sufficient space around the trowel (at least 2 m.);
7. Check that the two control levers are perpendicular, if necessary adjust them (see par. 4.3.2).

4.3 PRELIMINARY STARTUP OPERATIONS

Seat adjustment

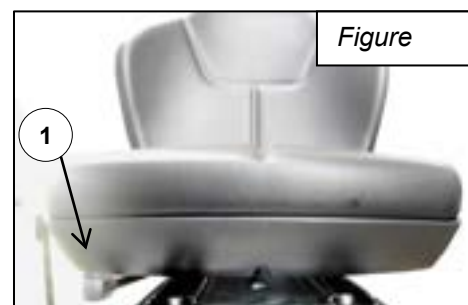

Figure

(Fig.4.7) For horizontal adjustment activate the lever under the seat, find the desired position and release the lever (1, fig. 4.6).

Control levers' adjustment

The steering levers (fig. 2.1 # 6 and 7) can be adjusted to make the driving operation easier, adapting them to the driver needs.

The levers must remain perfectly straight in the rest position. Wear and prolonged use over time may alter the location and may require adjustment.

To move the steering control levers forward or backward the operator must:

1. Arrange the blades in a horizontal position by activating the appropriate levers and adjust himself through the graduated bar present on the tubular fig. 4.8).



Figure 4.8
Figure 4.8

2. To perform this adjustment you need to intervene on the internal tie-rods, after having removed the aluminium cover lid unscrewing the 6 fixing screws.
3. Remove the retainer clip of the tie rod joints;
4. Remove the tie rod from its seat, pulling the joint off;
5. Adjust the tie rod end:
 - By rotating the joint in a clockwise direction the levers are moved outwards (FORWARD)
 - By rotating the joint counter-clockwise the levers move inwards (BACKWARD).
6. Reposition the joint and keep it in place by means of the clip, repeating in reverse the operations previously described.
7. Finally replace the cover previously removed.

To move the steering control levers to the right or to the left the operator must:

1. Remove the retainer clip of the tie rod joints;
2. Remove the tie rod from its seat, pulling the joint off;
3. Adjust the tie rod end:
 - By rotating the joint clockwise the levers move to the left;
 - By rotating the joint counter-clockwise the levers move to the right;

Reposition the joint and fix the clip.

Fuel filling



CAUTION

- **CAUTION** *Danger of explosion and fire.* Fill the tank only in an open space, away from heat sources. Do not smoke. Do not refuel while the engine is running or hot.

1. Clean the area around the fuel cap.
2. Remove the cap.
3. Fill the tank up to 3-4 centimetres from the upper edge of the tank to allow the fuel to expand.
4. Replace the tank cap.
5. Always clean the area of the cap thoroughly by removing any small leaks.

Engine oil filling

Refer to the engine manual attached and to the MAINTENANCE CHAPTER OF THIS PUBLICATION. Refer to par. 6.2.5 to perform the engine oil filling.

4.4 ENVIRONMENTAL CONDITIONS

The device must be used while being protected from the weather conditions. The environments of operation should be well ventilated and in compliance with current legislation on hygiene and safety at work.

CAUTION



- Do not approach the machine to open flames or other similar sources.
- Do not use the machine in places where there is a risk of explosion and fire: the machine is not in compliance with the directive ATEX (ex-2014/34/EU). Exhaust fumes include carbon monoxide a dangerous and deadly gas. Never run the engine indoors or in poorly ventilated premises.



4.5 STARTING THE WORK CYCLE

After performing the preliminary checks at startup described in the previous paragraph (PAR. 4.3) you can start the machine by following the instructions below:

To start the trowel the operator must:

1. Settle himself into the driver's seat after having carefully adjusted its position,

placing his feet on the appropriate foot rest.

2. Make sure that the steering control is in the neutral position.
3. Close the choke lever (CHOKE).
4. Make sure that the petrol tap (Figure 4.9) is in the open position.
5. Move the throttle lever by hand to the minimum position.
6. Turn the key to start the machine.
7. (For petrol engines only) After start-up open the choke lever (CHOKE).

IMPORTANT!

For more detailed information on start-up procedures refer to the engine's instruction manual



- The engine's start-up occurs at low revs, the clutch has not yet triggered and rotors don't turn yet (the clutch triggers at 1500 rpm). To avoid skidding which would lead to a high clutch wear bring the accelerator to a value of up to 2500 revolutions per minute.

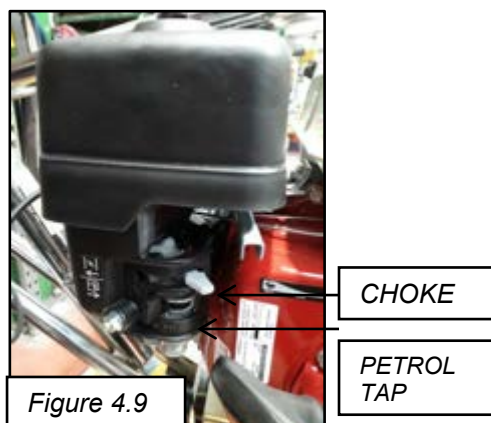

4.6 TROWEL STEERING

To make the trowel move the operator must activate the trowel control levers according to the diagram in par. 5.5. of this publication.

IMPORTANT!

Use the machine at a reduced speed until you have a perfect mastery of steering and operation.

To direct the machine in the desired direction, there are two control levers. The operator must slowly and smoothly move the steering levers. To stop the trowel movement you can simply slip the steering levers back into the rest position.

Chapter 5 (PAR. 5.5) of this manual includes the positions of the control levers and the relative displacements.

4.7 TROWEL STOP

To stop the troweling machine, take the following steps:

1. Bring the accelerator to idle speed.
2. Bring the steering levers in an upright position.
3. Close the throttle activating the black lever shown in figure 4.9.
4. Close the petrol tap.
5. Remove the ignition key from the control panel.

4.8 RESTARTING THE TROWEL

To restart the machine it is necessary to repeat the start-up process (PAR. 4.5).

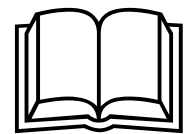

CHAPTER **5**

5 TROWEL USAGE

- 5.1 Safety warnings
- 5.2 Surface preparation
- 5.3 Troweling stage
- 5.4 Finishing stage
- 5.5 Layout of controls

5.1 SAFETY WARNINGS

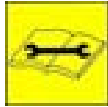

CAUTION

- ! During the working phases pay particular attention to possible control loss by the trowel (for example due to the presence of too much water on the working surface).

Check that there are no obstructions or obstacles on the work surface or protruding parts that block blade rotation.

CAUTION

- ! The user must be aware that the moving parts are dangerous; Therefore, to prevent damage, it is important that you follow the instructions provided in this manual.
Carefully read the instructions and recommendations included in this manual.

IMPORTANT!

For stability reasons it is recommended to use the machine on a very stable flat and horizontal place. Do not use the machine on slopes greater than 4%-5%.

5.2 SURFACE PREPARATION

IMPORTANT!

Consider carefully that the trowel does NOT improve the flatness of a floor which has been badly propped up or levelled.

We recommend the use of a mechanical vibrating screed or manual screed for striking off the floor surface. This preliminary operation will provide a good compaction of the concrete floor and consequently an ideal surface for troweling and finishing will be obtained.

5.3 TROWELING STAGE

IMPORTANT!

Before starting the troweling operation, make sure that the feather edge discs have been properly mounted on the blades.

The floor will be ready for the first troweling when the footprint of the shoe heel while walking is about 2-3 mm deep in the concrete. During the troweling stage the feather edge discs must not jump on the surface; this phenomenon may be due to dirt nestled between the blades and the feather edge disc. If necessary stop the trowel and clean it as described in the next chapter.

The troweling intervals depend on environmental factors, specifically: the temperature and weather conditions. On average ten minutes of troweling are enough for 250-300 square meters.

After each operation, shut down the engine.

CAUTION

- ! Use a special lifting gear to move it.
- In case you need to lift it more than 100 cm from the ground, preventively remove the feather edge disc as described in PAR. 6.2.3.

Never leave the trowel stopped with its engine on, especially at the troweling stage when the concrete is still fresh. **Be careful not to work continuously in the same spot when the concrete is still fresh, as it may cause damage to floor flatness.**

5.4 FINISHING STAGE

After you have performed troweling:

- Remove the feather edge disc from the blades and clean the blade-holding disk from the cement deposited during a troweling stage (make use of P.P.E).
- Turn the blade-lifting lever (as shown in fig. 5.1) clockwise up to give an inclination to blades of about 1 cm. to perform the first troweling;

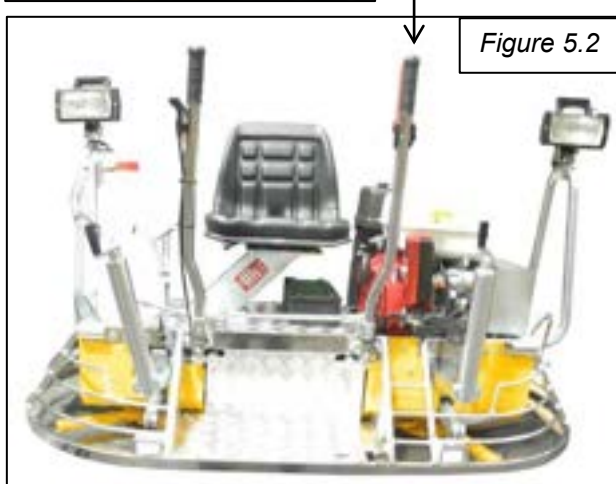

- For subsequent smoothing operations continue to increase the blade inclination until you obtain the desired finish.
- The time between one troweling operation and the next one is determined by the weather conditions (cold or warm) and the amount of water present in the concrete. If the concrete has hardened too fast in some areas it can be moistened by spraying water through the appropriate button (fig. 5.2).

CAUTION

- ! In the presence of too much water the troweling machine tends to skid; You shall make sure, especially at start-up, to always have the machine in control.

5.5 LAYOUT OF CONTROLS

FORWARD MOVEMENT
Push the driving levers forward

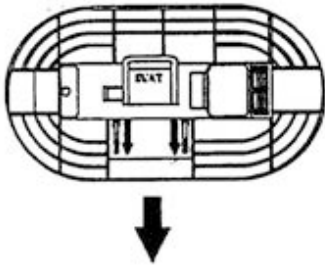

BACKWARD MOVEMENT
Pull the driving levers back

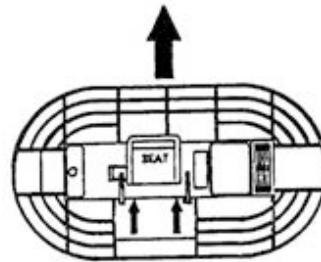

RIGHT SIDE MOVEMENT
Push the driving levers to the right

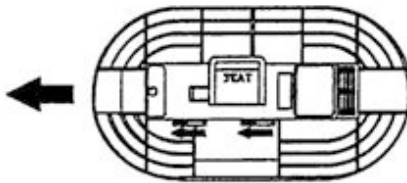

LEFT SIDE MOVEMENT
Push the driving levers to the left

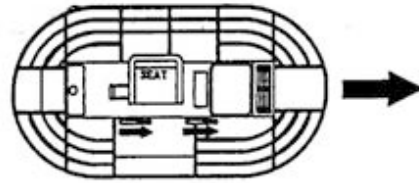

BEND TO THE RIGHT
Push left lever forward and
right lever backward

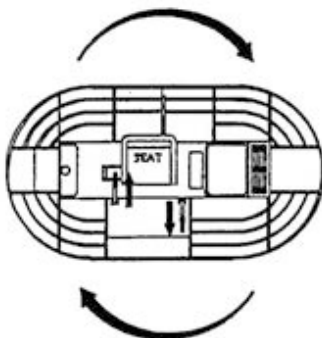

BEND TO THE LEFT
Push the right lever forward and
pull the left lever backward

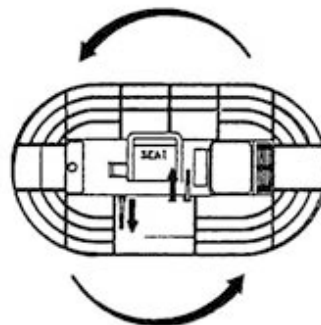

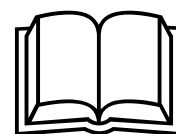

CHAPTER **6**

6 MAINTENANCE AND REPAIR

- 6.1 Scheduled maintenance
- 6.2 Routine and additional maintenance
- 6.3 Notes on dismantling
- 6.4 Troubleshooting
- 6.5 Parts List
- 6.6 Warranty



CAUTION



During the execution of maintenance tasks you must wear the following P.P.E.: CUT RESISTANT GLOVES AND SAFETY SHOES.

For certain types of activities (lubricant filling-up) make use of airway protection equipment as indicated in the residual risks.



Before carrying the maintenance of the machine ensure you understand the contents of this manual. Please contact the manufacturer for further explanations and information. Maintenance workers must possess the skills required by this manual, as well as the mental and physical requirements necessary and sufficient in order to operate the machine. To ensure the functionality and durability of the machine periodic maintenance must be performed, carrying out operations in compliance with the safety requirements.

Only the reseller (authorized dealer) can make adjustments and operations that are not assigned to the operator. It is forbidden to make adjustments and interventions during machine operation. Before performing any maintenance operation disconnect the machine from the power sources and wait for the cooling of the hot parts (engine, spark-plug area, air filter area).

CAUTION

Some operations of maintenance/replacement of worn components may only be carried out by the authorized dealer or the manufacturer's technician. They are reported later in this publication. Please note that failure to comply with the requirements of maintenance represents a possible MISUSE or PROHIBITED USE and relieves the manufacturer from any liability for damage to persons and property.

1. To stop the machine, bring the accelerator at idle speed, by activating the accelerator lever.

2. Release both control bars.
3. Close the petrol tap.
4. Stop the engine (position the switch to the OFF/0).
5. Remove the ignition key from the control panel.
6. Carry out maintenance operations with the machine stopped.

Before performing maintenance:

1. Thoroughly clean the trowel machine because due to wear the blades can become sharper. During maintenance check carefully the blade position and be equipped with anti-cutting gloves.

If in doubt about how to perform occasional repairs contact our Technical Support or authorized dealer.













2. Upon finishing the job perform a thorough cleaning from processing residues.
3. After the cleaning process, replace the feather edge disk under the blades to protect them from any damage caused by movement of the machine.









6.1 SCHEDULED MAINTENANCE

Good maintenance requires constant and methodical control of all parts of the machine and adaptation of tests to its actual usage. Periodic inspections are crucial to keep the machine efficient and reduce repairs and any resulting dangers.















We recommend that you have your reseller (AUTHORIZED DEALER) perform a general annual check.

Note: frequency is taken over considering a working day of 8 hours.

NAME OF THE OPERATOR	FREQUENCY	PERSON IN CHARGE	OPERATING INSTRUCTIONS	STATE OF THE MACHINE
MECHANICAL PARTS				
Check status and tightening of blade bolts	Daily		 Check the status of blade bolts. Perform tightening every day. If the bolts are worn, they must be replaced (THE MACHINE SHOULD BE FIRST RAISED ON ONE SIDE AND THEN ON THE OTHER TO CARRY OUT THE OPERATION ON BOTH SIDES) SEE PAR 6.2.1.	 Machine stopped/ Power sources disconnected
Engine air filter cleaning	Daily		Clean engine air filter, especially if you are working in dusty conditions or replace it; follow the instructions given in the engine manual.	 Machine stopped/ Power sources disconnected
Check for wear and transmission belts tension degree, cardan shaft greasing	Weekly		Follow the procedures in PAR. 6.2.4 in case of breakage or important wear of the belts to provide for their replacement.	 Machine stopped/ Power sources disconnected
Spark-plug cleaning	Weekly		 <p>If you need a replacement, refer to the engine manual attached to this publication. Be careful when removing the spark-plug:</p> <ul style="list-style-type: none"> • Wait for the engine to cool down • Remove the cap • Remove the spark plug and lay it down away from the spark-plug holder (because sparks may be triggered) 	 Machine stopped/ Power sources disconnected
Check clutch wear	Weekly		If you need to replace the brake mass you must ask for the intervention of the reseller (dealer)	

Visual inspection of the feather edge disc and its possible replacement	Monthly		Visually inspect the state of wear of the feather edge disks. If one or both the disks have undergone a dilation, action is needed to replace it/them (see PAR. 6.2.3).	 Machine stopped/ Power sources disconnected
Gearboxes	In case of leaks and at the time of installation	 In case of breakage or faults that cannot be resolved and require the replacement of the component, REFER TO SKILLED LABOR (AUTHORIZED DEALER).	<p>The gearboxes are sealed upon assembly; if you notice oil leaks, carefully find out their origin because there may be leaks from other sources.</p> <p>If the leaks come from the gearbox, contact our technical service or a qualified technician. Clean any oil leaks at the bottom of the trowel.</p> <div style="border: 1px solid black; padding: 5px; background-color: #f0f0f0;"> <p style="text-align: center;">CAUTION</p> <p style="text-align: center;">! IT IS FORBIDDEN TO REPLACE THE GEAR BOX. REFER TO THE MANUFACTURER OR THE RESELLER (SPECIALIZED MAINTENANCE TECHNICIAN).</p> </div> <p>For a possible change of the lubricant due to leaks or for the topping up operations, use the following types of lubricant: GLYGOYLE 30 OIL N.C.34039910</p>	 Machine stopped/ Power sources disconnected
Check state of blade wear and perform replacements if necessary	Daily		Follow the procedures in PAR. 6.2.1 for replacement	 Machine stopped/ Power sources disconnected
Adjustment of blade inclination degree	It is recommended to periodically perform the adjustment of the blade inclination degree		At the bench turn the adjusting screw and adjust the angle of blades. The operation can be carried out with the machine mounted with long keys.	 Machine stopped/ Power sources disconnected
Unlocking of blade holder arms and cover plate	If needed		Refer to the reseller (authorised dealer)	Machine stopped/ Power sources disconnected



Check of petrol level and supply	At each start	 Par. 4.3.3.	<p style="text-align: center;">CAUTION</p>  <ul style="list-style-type: none"> Make sure that the petrol contains no water and do not use mixtures or diesel. <p>Perform this operation in a well ventilated environment and away from possible sources of heat or flames. Make use of specific P.P.E. (mask) as shown in the residual risks table on page 20 of this publication.</p> <p>REFER TO THE ENGINE MANUAL.</p> 	 Machine stopped/ Power sources disconnected
Engine oil level check and possible replacement	Daily		Check the manufacturer's instructions present in the component's manual (attached to this publication) and in PAR. 6.2.5 of this publication	 Machine stopped/ Power sources disconnected
Fork replacement	If necessary (in case of breakage, see table of drawbacks)		This activity must be carried out exclusively by a specialised operator (RESELLER/AUTHORIZED DEALER)	Machine stopped/ Power sources disconnected
Battery	Weekly		Check battery charge and water level in the elements, if top off is necessary add distilled water only; Clean the two battery poles to remove oxidation.	 Machine stopped/ Power sources disconnected
General cleaning	Daily	 P.P.E. USE	Wash the dirty parts with a brush and water. Moisten the parts exposed to the cement with disarming oil (never fuel oil); Do not lubricate the rubber parts subjected to motion (belts, etc.).	 Machine stopped/ Power sources disconnected
SAFETY SYSTEMS				
SAFETY SYSTEMS (BELT GUARD)	Daily		Please note the requirement to perform the checking and recording of verifications of safety components every 6 months (pursuant to article 71 of the legislative decree 81.2008) .	Machine stopped/ Power sources disconnected
CHECK INTEGRITY OF PICTOGRAMS	At the shift start			Machine stopped/ Power sources disconnected
CHECK MICRO SEAT INTERVENTION	At the shift start		Please note the requirement to perform the checking and recording of verifications of safety components every 6 months	Machine in operation

			(pursuant to article 71 of the legislative decree 81.2008).	
--	--	--	---	--

6.2 ROUTINE AND ADDITIONAL MAINTENANCE

6.2.1 Replacement of blades



Check the state of wear of the blades or if they have been damaged or bent. To carry out the replacement of the blades proceed as follows:

- Clean the trowel from any processing residues;
- To perform this operation you must first lift the machine on one side, while keeping the support on the other side, by means of a special lifting gear as indicated in PAR. 3.2.



Figure 6.1

- Remove the fixing bolts (hexagon head screws 6x35) of the blades on each trowel arm (2 for each arm) (fig 6.1) by means of a suitable tool (screwdriver or hexagonal-head wrench, size 13).
- Assemble the new blades fixing the screws with their split washers.
- Repeat the operation on the other side of the machine.



IMPORTANT!

For a correct operation of the trowel, in the event breakage or damage of one or more blades, replace all the blades.

6.2.2 Unlocking of blade holder arms and of cover plate



If the blade-lifting control does not work, this may be due to blockage of blade-holding arms or of the cover plate.

Unlocking of the blade-holding arms and of the cover plate or any replacement of the blade-holding arms.

To unlock the blades and the cover plate refer to the reseller (authorized dealer).

6.2.3 Feather edge disc replacement



IMPORTANT!

Before performing the operation clean the blades from cement residues. Use cut-resistant gloves.

Feather edge disks are subject to wear that is indicated by their expansion. If, as a result of a visual inspection, this is the case, replace any damaged disk or disks.

Do as follows:

At the bench or on the ground lift the machine as prescribed in PAR. 3.2

- On the ground unhook the blades from the clasps (there are 2 or 4 clasps on the feather edge disc depending on the number of blades), slightly lifting the machine (approximately 10 cm) through the four hooks supplied (fig 6.1).



Figure 6.2

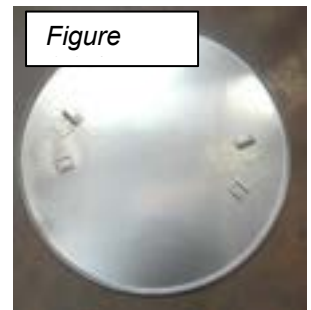

Figure

- The feather edge disc remains on the ground once released from the blades (fig. 6.2.1).
- Replace the disk or disks, inserting the feather edge discs on the blades, checking the direction of rotation.
- After the installation of new discs replace the troweling machine on the ground or on the bench.

6.2.4 Replacement of the belt(s)



If, as a result of a visual inspection, it appears that the belts are worn or cracked, replace them, operating as follows:

- Remove the fixed guard of segregation of the belt and loosen the locknut.
- Use an appropriate tool on the tensioning screw (1, fig. 6.3) by turning counterclockwise to release tension and allow the removal of belts (to tension turn clockwise).

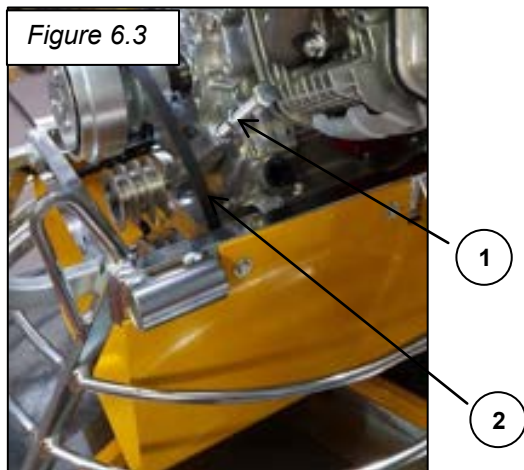

- Remove the worn belts (2), by turning the pulley, by leveraging with a tool to remove the belt to be replaced and replace it with another of the same size.
- Mount the new belt(s), by rotating the pulley to position it correctly;
- Mount the previously removed fixed guard for belt segregation.

6.2.5 Engine oil filling



Refer to the engine manual attached and to the MAINTENANCE CHAPTER OF THIS PUBLICATION. The oil filling must be performed with the machine off after waiting for the cooling of hot parts.

THE ENGINE OIL TOPPING OFF CAN BE CARRIED OUT WITH THE MACHINE IN THE WORKING POSITION.

1. At first proceed by emptying the tank through unscrewing the nut that closes the exhaust visible in the figure (B) below.

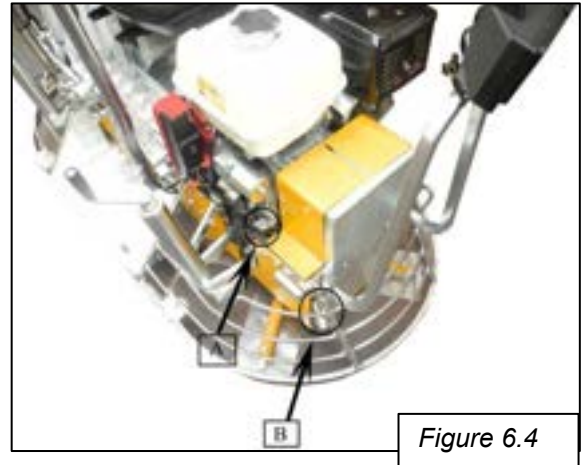

Figure 6.4

2. Then perform the oil topping off after having checked the level on the graduated dipstick integrated into the cap.
3. If necessary top off with oil of the type shown in the warning (important!) until the notch in the upper end of the dipstick.
4. Screw the cap back on and tighten securely.

6.2.6 Replacement of brake linings or pads



1. Remove the fixed guard of the belts area and subsequently the protective cover of the clutch as well by tightening the three allen screws;
2. To replace the brake linings, you can simply extract them;
3. To replace the inner bearing to the clutch, unscrew the central screw in order to remove the clutch and work from the inside.
4. After these operations replace the cover and the fixed guard of the belt area.

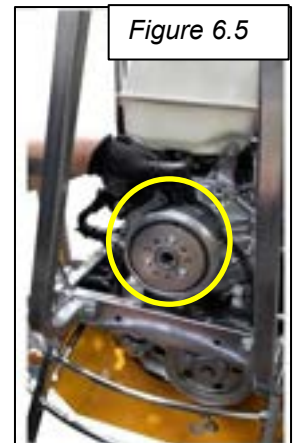

Figure 6.5

6.2.7 Gearmotor oil filling



IMPORTANT!

TO AVOID DAMAGE TO THE MACHINE STRICTLY USE THE FOLLOWING TYPE OF LUBRICANT: GLYGOYLE 30 OIL N.C.34039910

The machine is equipped with two gearmotors: Periodically check the oil level of the gear units and IN CASE OF LEAKS OR NEED PERFORM OIL TOPPING OFF.

There are two caps on the side face of the two gearboxes: the top cap detects the oil level of the box itself.

Be especially careful if you see oil at the bottom of the trowel;

1. Perform a thorough cleaning and check the origin of the leak;
2. If topping off is necessary, proceed as follows:
3. When the machine is stopped, wait until the engine has cooled down;
4. Remove the cap from the gear box that also works as a level indicator (figure below).

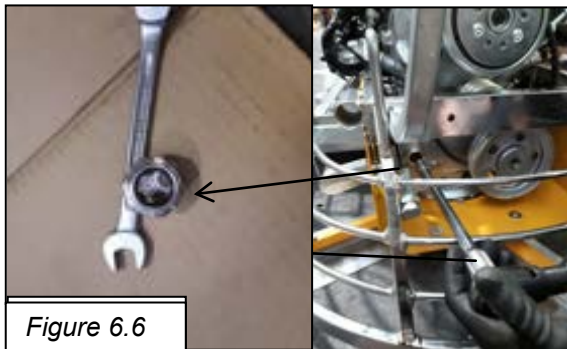

Figure 6.6

If necessary, perform topping off, taking care to lift the machine from the opposite side to that of the topping up following the procedures outlined in PAR. 3.2 of this publication.

Repeat the same operations from the opposite side.



6.3 NOTES ON DISMANTLING

As regards dismantling activities there are no security-related or environmental problems.

In case you wish to proceed with the dismantling of the various machine parts, it is necessary to pay attention to their movement taking into account the respective masses to be handled.

In case of machines used in working environments it is necessary to dispose of the **electrical and electronic products**, if any, contained in them in accordance with the current legislation.

The European legislation currently in force requires such kinds of waste to be disposed of according to specific procedures.

IMPORTANT

Do not dispose into the environment products which are not biodegradable, lubricant oils and relevant filters as

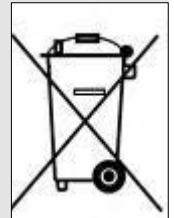

well as non-ferrous parts (rubber, PVC, etc.). Perform their disposal in accordance with the laws in force and before taking care of this disposal, consult your reseller in order to check whether there are specific programs of withdrawal.

IMPORTANT

At the time of dismantling, the user shall be required to recover the identification plate of the equipment to prevent the machine from being put back into service without its guards because the MANUFACTURER IS NO LONGER HELD RESPONSIBLE.

6.4 TROUBLESHOOTING



ISSUES	CAUSES	REMEDIES
Trowel oil leakage	Gearbox cover screws are loose	Tighten the screws
	Faulty seals	Contact the authorized service
	Oil seal worn central and lateral shaft	Contact the authorized service
	Engine oil leakage	Contact the authorized service
The engine does not start	Low fuel	Fill the fuel tank suitable for the engine used.
	Fuel tap closed	Open the petrol tap (*)
	Petrol filter clogged	Replace the filter (*)
	Choke lever fully open (in this case the machine "jerks")	Close the choke lever (*)
	No spark	Clean the spark plug and, if necessary, replace it (*) Check connection pin (*)
	Flooded engine/ignition trouble	Unscrew the spark plug and dry it
The engine speed falls	Accelerator cable broken or bent	Replace accelerator cable
	Engine trouble	Contact the authorized service
	Dirty carburettor	Contact the authorized service
	Clogged air filter	Clean or replace air filter (*)
		
The trowel goes neither forward nor backward	Broken tie rod (internal or external tie rods)	Replace tie rod (internal or external tie rods)
	Retainer clip of the tie-rods is broken or unthreaded	Replace the clip if broken
	Swivel support seized	Contact the authorized service
The trowel steers neither to the right nor to the left	Broken ball joints	Replace the ball joints (contact the authorized service)
	Rim supports broken	Replace rim supports (contact the authorized service)
	Steering holders out of housing	Adjust steering supports (contact the authorized service)

ISSUES	CAUSES	REMEDIES
The blades do not get up	Steel wire broken	Replace blade-lifting wire (contact the authorized service)
	Fork broken	Replace the fork (contact the authorized service)
The trowel jumps on the floor	Hardened concrete under the cross or blades	Clean the cross and blades
	Blades worn unevenly	Adjust blade inclination (page 42)
	Central shaft bent (blocked cover plate or cross)	Contact the authorized service
	Steering control is not perfectly vertical	Adjust the position of the steering control (PAR. 4.2.3)
	Blades not duly adjusted	Adjust the blades
With the engine revved, the rotors do not turn	Loose and/or worn transmission belts	Tighten the transmission belts or replace them (PAR. 6.2.4)
	Brake linings or clutch pads worn	Replace brake linings or pads (PAR. 6.2.6)

(*) REFER TO THE ENGINE MANUAL WHICH IS AN INTEGRAL PART OF THE SUPPLY

6.5 PARTS LIST

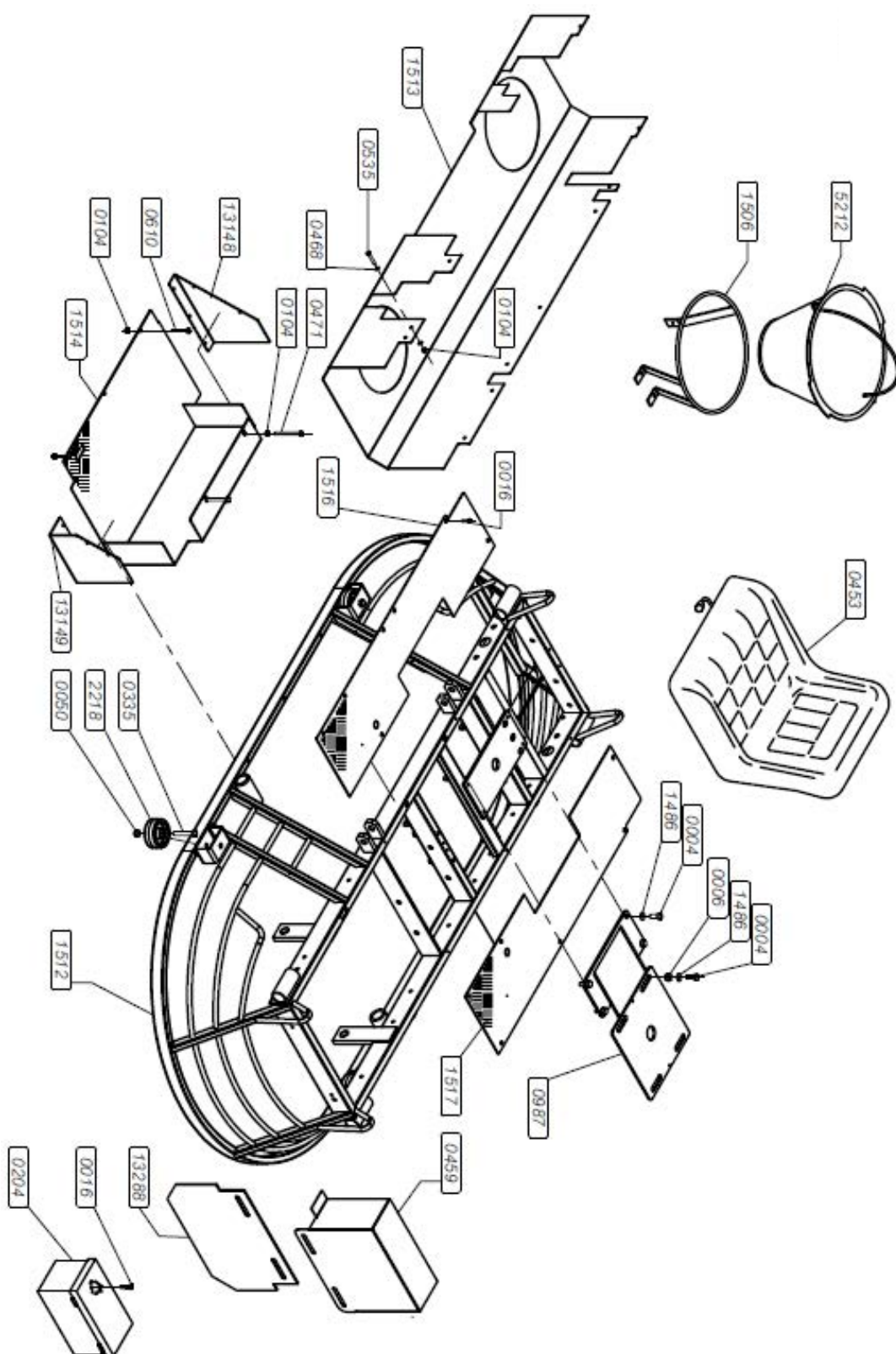

 **MK8-75**

TABLE
TAVOLA
A1

COD.	DESCRIZIONE (I)	DESCRIPTION (GB)
0004	VITE TE 8x20 UNI 5739 Z.B.	HEXAGONAL SCREW 8X20
0006	DADO M8 UNI 5588 Z.B.	NUT M8 UNI 5588 GALVANIZED WHITE
0016	VITE AUTOFIL.4,8X16 UNI 6950	SELF-TAPPING SCREW 4,8X16 UNI 6950
0050	DADO BLOKM8 DIN 985 Z.B.	SELF-LOCKING NUT M8 DIN 985 GALVANIZED WHITE
0104	DADO BLOKM6 -DIN 985 Z.B.	SELF-LOCKING NUT M6 -DIN 985 GALVANIZED WHITE
0204	CASSETTA PORTA ATTREZZI	TOOL BOX
0335	VITE TE 8x50 5737 Z8 10.9	SCREW HEX HEAD 8x50 5737 GALVANIZED WHITE
0453	SEDILE GT60 MK8-75 C/GUIDE	DRIVER SEAT GT60 MK8-75
0459	CARTER PROTEZ.CINGHIA MK8-75	GUARD BELT MK8-75
0468	RONDELLA 6x18X1,5 Z.B.	WASHER 6x18X1,5 GALVANIZED WHITE
0471	VITE TE 6x65 5737 Z.B.	SCREW HEX HEAD 6x65 5737 GALVANIZED WHITE
0535	VITE TE 6x35 UNI 5737 Z.B.	SCREW HEX HEAD 6x35 UNI 5737 GALVANIZED WHITE
0610	VITE TE 6x40 UNI 5737 Z.B.	SCREW HEX HEAD 6x40 UNI 5737 GALVANIZED WHITE
0987	PIANTONE SEDILE	SEAT SUPPORT
13148	CARTER PROTEZIONE DX MK8-75	CARTER PROTECTION DX MK8-75
13149	CARTER PROTEZIONE SX MK8-75	CARTER PROTECTION SX MK8-75
13288	CARTER PROT.CINGHIA INFERIORE	LOWER GUARD BELT
1486	RONDELLA ZIGRINATA D.8 Z.B.	WASHER D.8 GALVANIZED WHITE
1506	PORTASECCHIO PER MK8-75 Z.B.	BUCKET HOLDER
1512	TELAIO PROTEZ.MK8-75	PROTECTION FRAME MK8-75
1513	TUNNEL PROT.MK8-75	PROTECTION TUNNEL MK8-75
1514	PEDANA APPOG.PIEDI MK8-75	FOOT BOARD MK8-75
1516	PEDANA SUPER.ANTER.MK8-75	FRONT BOARD MK8-75
1517	PEDANA SUPER.POSTER.MK8-75	REAR BOARD MK8-75
2218	RUOTA IN NYLON BIANCO D.60X22	WHITE NYLON WHEEL D.60X22
5212	SECCHIO PLASTICA COLORE NERO	BLACK BUCKET



ENGINE / MOTORE HONDA GX390 13HP (CODE 3206)
 ENGINE / MOTORE ROBIN EX40 14HP (CODE 3207)

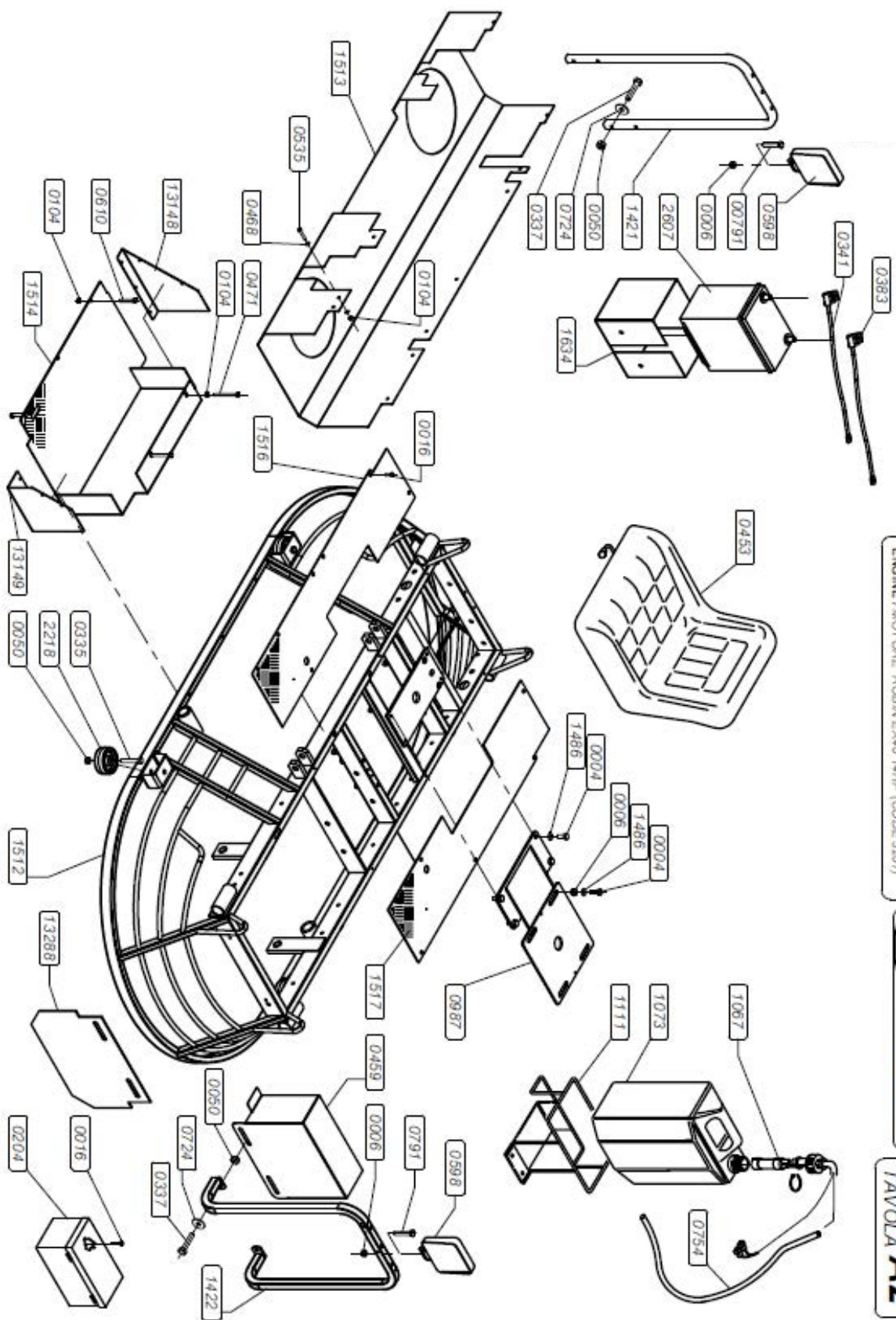

MK8-75

TABLE
 TAVOLA **A2**

COD.	DESCRIZIONE (I)	DESCRIPTION (GB)
0004	VITE TE 8x20 UNI 5739 Z.B.	HEXAGONAL SCREW 8X20
0006	DADO M8 UNI 5588 Z.B.	NUT M8 UNI 5588 GALVANIZED WHITE
0016	VITE AUTOFIL.4,8X16 UNI 6950	SELF-TAPPING SCREW 4,8X16 UNI 6950
0050	DADO BLOKM8 DIN 985 Z.B.	SELF-BLOCKING NUT M8 DIN 985 GALVANIZED WHITE
0104	DADO BLOKM6 -DIN 985 Z.B.	SELF-BLOCKING NUT M6 -DIN 985 GALVANIZED WHITE
0204	CASSETTA PORTA ATTREZZI	TOOL BOX
0335	VITE TE 8x50 5737 ZB 10.9	SCREW HEX HEAD 8x50 5737 GALVANIZED WHITE
0337	VITE TE 8x40 5737 Z.B.	SCREW HEX HEAD 8x40 5737 GALVANIZED WHITE
0341	CAVO POSITIVO X DOPPIE L=2000	BATTERY CABLE POSITIVE L=2000
0383	CAVO NEGAT.C/MORS.BAT.27160	BATTERY CABLE NEGATIVE 27160
0453	SEDILE GT60 MK8-75 C/GUIDE	DRIVER SEAT GT60 MK8-75
0459	CARTER PROTEZ.CINGHIA MK8-75	GUARD BELT MK8-75
0468	RONDELLA 6x18X1,5 Z.B.	WASHER 6x18X1,5 GALVANIZED WHITE
0471	VITE TE 6x65 5737 Z.B.	SCREW HEX HEAD 6x65 5737 GALVANIZED WHITE
0535	VITE TE 6x35 UNI 5737 Z.B.	SCREW HEX HEAD 6x35 5737 GALVANIZED WHITE
0598	FARO LED	LED HEADLIGHT
0610	VITE TE 6x40 UNI 5737 Z.B.	SCREW HEX HEAD 6x40 UNI 5737 GALVANIZED WHITE
0724	RONDELLA 8x24 - ZINCATA BIANCA	WASHER 8x24 - GALVANIZED WHITE
0754	TUBO ARMORVIN HNA 10 RIF. RPQ0191	PIPE ARMORVIN HNA 10 RIF. RPQ0191
0791	VITE TE 8x45 UNI 5737 Z.B.	SCREW HEX HEAD 8x45 UNI 5737 Z.B.
0987	PIANTONE SEDILE OL90/120 MK8-75/90/120	SEAT SUPPORT OL90/120 MK8-75/90/120
1067	POMPA ACQUA 12.V+CONNETTORE	WATER PUMP 12.V+CONNECTOR
1073	TANICA ACQUA LT.15 CCC0206	WATER TANK LT.15 CCC0206
1111	PORTA TANICA	SUPPORT FUEL TANK
13148	CARTER PROTEZIONE DX MK8-75	CARTER PROTECTION MK8-75 RIGHT
13149	CARTER PROTEZIONE SX MK8-75	CARTER PROTECTION MK8-75 LEFT
13288	CARTER PROTEZ.INFER.CINGHIA MK8-75	LOWER GUARD BELT
1421	SUPPORTO FARO DESTRO	RIGHT HEADLIGHT SUPPORT
1422	SUPPORTO FARO SINISTRO	LEFT HEADLIGHT SUPPORT
1486	RONDELLA ZIGRINATA D.8 Z.B.	WASHER D.8 GALVANIZED WHITE
1512	TELAIO PROTEZ.MK8-75	PROTECTION FRAME MK8-75
1513	TUNNEL PROT.MK8-75	PROTECTION TUNNEL MK8-75
1514	PEDANA APPOG.PIEDI MK8-75	FOOT BOARD MK8-75
1516	PEDANA SUPER.ANTER.MK8-75	FRONT BOARD MK8-75
1517	PEDANA SUPER.POSTER.MK8-75	REAR BOARD MK8-75
1634	SCATOLA PORTABATTERIA MK8-75	BATTERY HOLDER BOX MK8-75
2218	RUOTA IN NYLON BIANCO D.60X22	WHITE NYLON WHEEL D.60X22
2607	BATTERIA 12V 35AH EUROSTAR DX	BATTERY 12V 35AH EUROSTAR DX

COD.	DESCRIZIONE (I)	DESCRIPTION (GB)
0004	VITE TE 8x20 UNI 5739 Z.B.	HEXAGONAL SCREW 8X20
0006	DADO M8 UNI 5588 Z.B.	NUT M8 UNI 5588 GALVANIZED WHITE
0016	VITE AUTOFIL.4,8X16 UNI 6950	SELF-TAPPING SCREW 4,8X16 UNI 6950
0050	DADO BLOKM8 DIN 985 Z.B.	SELF-BLOCKING NUT M8 DIN 985 GALVANIZED WHITE
0104	DADO BLOKM6 -DIN 985 Z.B.	SELF-BLOCKING NUT M6 -DIN 985 GALVANIZED WHITE
0199	TAPPO SERBATOIO	TANK CAP
0200	SERBATOIO BENZINA C/RACCORDO 90° S/GUARN	COMPLETE PETROL TANK
0204	CASSETTA PORTA ATTREZZI	TOOL BOX
0335	VITE TE 8x50 5737 ZB 10.9	SCREW HEX HEAD 8x50 5737 GALVANIZED WHITE
0337	VITE TE 8x40 5737 Z.B.	SCREW HEX HEAD 8x40 5737 GALVANIZED WHITE
0341	CAVO POSITIVO X DOPPIE L=2000	BATTERY CABLE POSITIVE L=2000
0383	CAVO NEGAT.C/MORS.BAT.27160	BATTERY CABLE NEGATIVE 27160
0453	SEDILE GT60 MK8-75 C/GUIDE	DRIVER SEAT GT60 MK8-75
0468	RONDELLA 6x18X1,5 Z.B.	WASHER 6x18X1,5 GALVANIZED WHITE
0471	VITE TE 6x65 5737 Z.B.	SCREW HEX HEAD 6x65 5737 GALVANIZED WHITE
0535	VITE TE 6x35 UNI 5737 Z.B.	SCREW HEX HEAD 6x35 5737 GALVANIZED WHITE
0589	TUBO CARBOPRESS NV 8X14 ECO	FLEX PIPE NV 8X14 ECO
0598	FARO LED	LED HEADLIGHT
0610	VITE TE 6x40 UNI 5737 Z.B.	SCREW HEX HEAD 6x40 UNI 5737 GALVANIZED WHITE
0724	RONDELLA 8x24 - ZINCATA BIANCA	WASHER 8x24 - GALVANIZED WHITE
0754	TUBO ARMORVIN HNA 10 RIF. RPQ0191	PIPE ARMORVIN HNA 10 RIF. RPQ0191
0791	VITE TE 8x45 UNI 5737 Z.B.	SCREW HEX HEAD 8x45 UNI 5737 Z.B.
0987	PIANTONE SEDILE OL90/120 MK8-75/90/120	SEAT SUPPORT OL90/120 MK8-75/90/120
10005	PORTA TANICA BENZINA PER B&S 18HP S/SERB	PETROL TANK HOLDER
1067	POMPA ACQUA 12.V+CONNETTORE	WATER PUMP 12.V+CONNECTOR
10459	CARTER PROT.SUPER.CINGHIA MK8-75 B&S18HP	GUARD BELT MK8-75 B&S 18 HP
1070	FASCETTA VELOX 5 TUBO 8-19	CLAMP VELOX 5 8-19
1073	TANICA ACQUA LT.15 CCC0206	WATER TANK LT.15 CCC0206
1112	PORTA TANICA	SUPPORT FUEL TANK
13148	CARTER PROTEZIONE DX MK8-75	CARTER PROTECTION MK8-75 RIGHT
13149	CARTER PROTEZIONE SX MK8-75	CARTER PROTECTION MK8-75 LEFT
13288	CARTER PROTEZ.INFER.CINGHIA MK8-75	LOWER GUARD BELT
1421	SUPPORTO FARO DESTRO	RIGHT HEADLIGHT SUPPORT
1422	SUPPORTO FARO SINISTRO	LEFT HEADLIGHT SUPPORT
1476	RACCORDO PER SERBATOIO	TANK CONNECTION
1486	RONDELLA ZIGRINATA D.8 Z.B.	WASHER D.8 GALVANIZED WHITE
11512	TELAIO PROTEZ.MK8-75 B&S	PROTECTION FRAME MK8-75 B&S
1513	TUNNEL PROT.MK8-75	PROTECTION TUNNEL MK8-75
1514	PEDANA APPOG.PIEDI MK8-75	FOOT BOARD MK8-75
1516	PEDANA SUPER.ANTER.MK8-75	FRONT BOARD MK8-75

1517	PEDANA SUPER.POSTER.MK8-75	REAR BOARD MK8-75
1634	SCATOLA PORTABATTERIA MK8-75	BATTERY HOLDER BOX MK8-75
2218	RUOTA IN NYLON BIANCO D.60X22	WHITE NYLON WHEEL D.60X22
2607	BATTERIA 12V 35AH EUROSTAR DX	BATTERY 12V 35AH EUROSTAR DX

COD.	DESCRIZIONE (I)	DESCRIPTION (GB)
0035	DADO BLOKM10 -985 - Z.B.	SELF-LOCKING NUT M10 -985 GALVANIZED WHITE
0050	DADO BLOKM8 DIN 985 Z.B.	SELF-LOCKING NUT M8 DIN 985 GALVANIZED WHITE
0053	DADO M14 BASSO UNI 5589 Z.B.	NUT M14 UNI 5589 GALVANIZED WHITE
0082	SNODO AD ANGOLO LHSA 14 C/TESTA CARBONIT	BALL ARTICULATION LHSA 14 C/HEAD CARBONIT
0084	VITE TE 10x45 UNI 5737 Z.B.	SCREW HEX HEAD 10x45 UNI 5737 GALVANIZED WHITE
0092	RONDELLA GROWER 14 DIN7980 Z.B	GROWER 14 DIN7980 GALVANIZED WHITE
0101	INGRASSATORE M6X1	GREASE FITTING M6X1
0121	DADO BLOKM14 BASSO 7474 Z.B	SELF-LOCKING NUT M14 BASSO 7474 GALVANIZED WHITE
0158	VITE TE 10x55 5737 Z.B.	SCREW HEX HEAD 10x55 5737 GALVANIZED WHITE
0273	DADO BLOK M12 985 ZB	SELF-LOCKING NUT M12 985 GALVANIZED WHITE
0337	VITE TE 8x40 5737 Z.B.	SCREW HEX HEAD 8x40 5737 GALVANIZED WHITE
0465	GRANO M6x8 -5927	DOWEL M6x8 -5927
0499	SPINA ELASTICA 6x30	UNIVERSAL PIN 6x30
0504	PRIGIONIERO M14 L=140 ZB OL-90/MK8-75	STUD M14 L=140 ZB OL-90/MK8-75
0506	TIRANTE M14 L=185 Z.B.x doppie	TIEROD M14 L=185 GALVANIZED WHITE
0509	SUPPORTO UCFL 204 FK	SUPPORT UCFL 204 FK
0511	COPPIA LEVA DX L=148 OL90 MK8-75	RIGHT LEVER L=148 OL90 MK8-75
0514	VITE TE 14x40 5739 ZB	SCREW HEX HEAD M14x40 5739 GALVANIZED WHITE
0515	LEVA TRASLAZIONE OL-90/MK8-75 D.20 L=395	SIDE TRANSLATION LEVER OL90/MK8-75 D.20
0567	LEVA TRASLAZIONE LATER.	SIDE TRANSLATION LEVER
0571	TIRANTE M14 L=95 OL90/120 MK8-75/90/120	TIEROD M14 L=95
0614	PRIGIONIERO M14 L=300 ZB OL90 MK8-75/120	TIE ROD M14 L=300 ZB OL90/75
0714	VITE VSP 14x45 - 5933 Z.B.	SCREW C.F.H. 14x45 - 5933 GALVANIZED WHITE
1040	FILO C/GUAINA 1,5x1900x1800 -	CABLE SHEATH 1,5x1900x1800
1158	BLOCCHETTO PER ASTA GUIDA PER DOPPIE	GUIDE ROD LEVER
1191	STOP BENZINA D.27 + FILO ELETT	PETROL STOP D.27 + ELECTRIC CABLE
1192	MANOPOLA CHIUSA D.27	KNOB CLOSE D.27
1194	BUSSOLA D.26-22-15 L=16	SLEEVE D.26-22-15 L=16
1195	BUSSOLA 18-12 L=12 DIN 179/C	SLEEVE 18-12 L=12 DIN 179/C
1215	RONDELLA PIANA 10x30 Z.B.	WASHER 10x30 GALVANIZED WHITE
1217	VITE TE 10X30 UNI 5739 Z.B.	SCREW HEX HEAD M10X30 UNI 5739 GALVANIZED WHITE
1360	COPPIA LEVA SX L=255 MK8-75	LEFT LEVER L=255 MK8-75
1510	LEVA ACCELERATORE IN PLASTICA	PLASTIC LEVER ACCELERATOR
1515	DISTANZIALE ARRETR.LEVA MK8-75 Z.B.	SPACER LEVER MK8-75 GALVANIZED WHITE
1635	TERMIN.SNODO MARCA "SB" JAM 14	TERMIN.ARTICULATION "SB" JAM 14
1636	TERMIN.SNODO MARCA "SB" JAF 14	TERMIN.ARTICULATION "SB" JAF 14
1870	VITE M12 CH19 L=70 Z.B. CARBONITRURATA	SCREW M12 CH19 L=70 G.W. CARBONITRIDING
1978	ASTA GUIDA PER DOPPIE	GUIDE ROD FOR RIDE-ON MACHINES

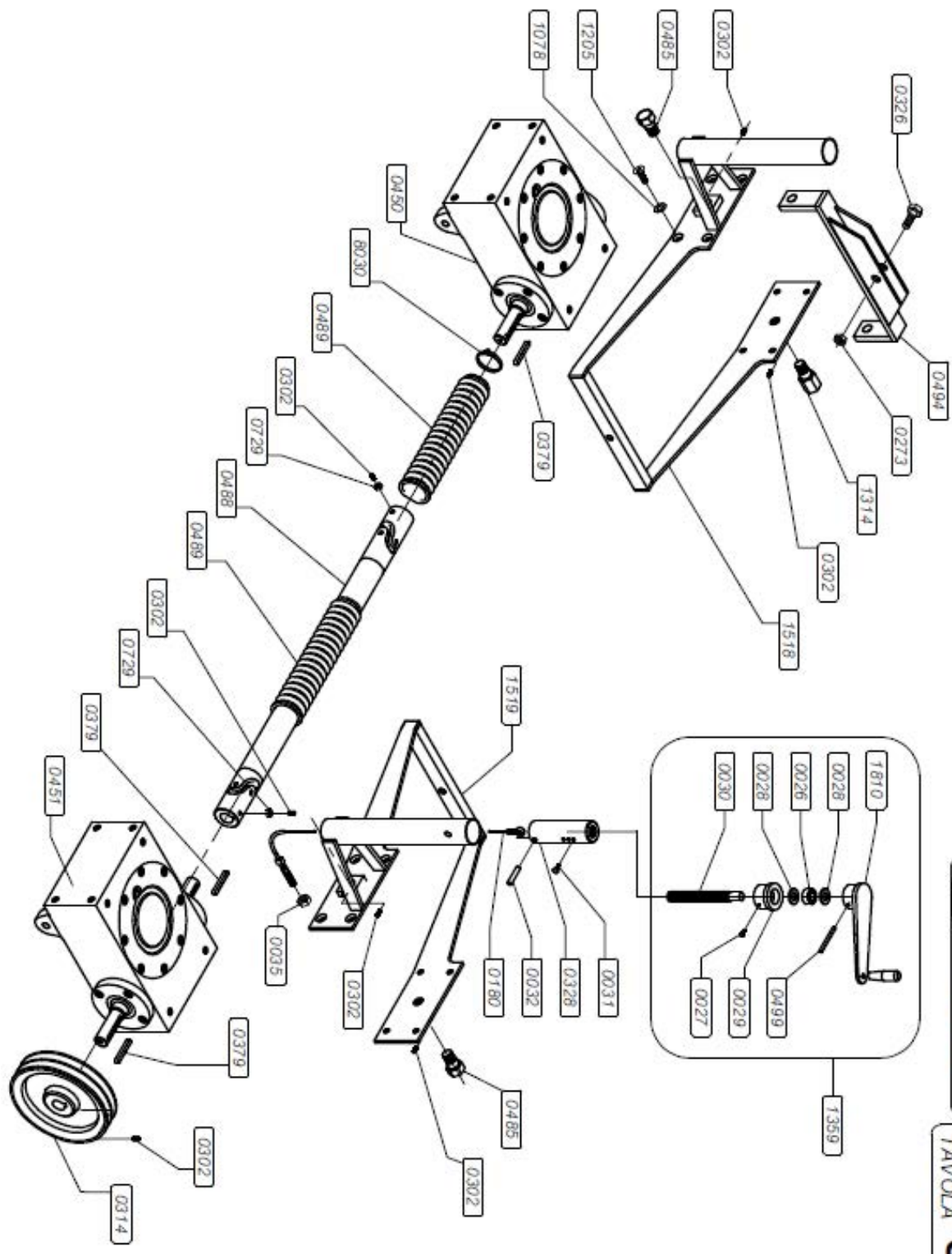

MK8-75
TABLE
TAVOLA
C

COD.	DESCRIZIONE (I)	DESCRIPTION (GB)
0026	CUSCINETTO REGGISPINTA AXK1528	BEARING THRUST AXK1528
0027	VITE TCCE 5x10 5931 Z.B.	SCREW TCCE 5x10 5931 GALVANIZED WHITE
0028	RALLA AS 1528	BOLSTER AS 1528
0029	ANELLO PORTACUSC.REGGISPINTA	RING BEARING THRUST
0030	PERNO FILETTATO x REGIST. PALE	PIN THREAD FOR REGIS. TOOLHOLDER
0031	VITE TCCE 6x10 5931 Z.B.	SCREW TCCE 6x10 5931 GALVANIZED WHITE
0032	SPINA CILINDRICA 8x40 UNI 1707	UNIVERSAL PIN 8x40 UNI 1707
0035	DADO BLOKM10 -985 - Z.B.	SELF-LOCKING NUT M10 -985 GALVANIZED WHITE
0180	CAVO D.4x49x340 C/TERM. x mk8-75	CABLE D.4x49x340 C/TERM. x mk8-75
0273	DADO BLOK M12 985 ZB	SELF-LOCKING NUT M12 985 GALVANIZED WHITE
0302	GRANO M6x16 - 5927	DOWEL M6x16 - 5927
0314	PULEGGIA ALL/GHISA 140x2A D.20H7	PULLEY ALL/CAST IRON 140x2A D.20H7
0326	VITE TE 12x60 5737 Z.B.	SCREW TE 12x60 5737 GALVANIZED WHITE
0328	ATTACCO SUPERIORE x CAVO DI REGISTRO	SUP.ATTACHMENT FOR REGISTER CABLE
0379	CHIAVETTA 6X6X35 - 6604 C45	KEY 6X6X35 - 6604 C45
0450	RIDUTTORE COMPL.V75 DX S/MUS.	REDUCTION GEAR COMPL.V75 DX S/MUS.
0451	RIDUTTORECOMPL.V75 SX S/MUS.	REDUCTION GEAR COMPL.V75 SX S/MUS.
0465	GRANO M6x8 -5927	PIN M6x8 -5927
0485	VITE BASCULANTE M14 L=37,5 CH22 ZB (3PZ)	SCREW M14 L=37,5 CH22 ZB (3PZ)
0488	ALBERO CARDANO OL90/MK8-75	GIMBAL OL90/MK8-75
0489	CUFFIA PROTEZIONE CARDANO	DUST BOOT GIMBAL
0494	PONTE BASCULANTE OL-90/MK8-75	STIRRUP OVERHEAD OL-90/MK8-75
0499	SPINA ELASTICA 6x30	UNIVERSAL PIN 6x30
0729	DADO M6 5589 BASSO Z.B.	LOW NUT M6 5589
1078	RONDELLA ZIGRIN.D10 ZINC.B.	WASHER D10 GALVANIZED WHITE
1205	VITE TE 10x20 UNI 5739 Z.B.	SCREW TE 10x20 UNI 5739 GALVANIZED WHITE
1314	VITE BASCUL.M14 L=50 OL90-75 (1PZ)	SCREW M14 L=50 OL90-75 (1PZ)
1359	GRUPPO ALZAPALE C/MANOPIOLA	BLADE LIFTER UNIT W/CRANK
1518	BASCULANTE DX MK8-75	RH SUPPORT REDUCTION GEAR MK8-75
1519	BASCULANTE SX MK8-75	LH SUPPORT REDUCTION GEAR MK8-75
1810	LEVA ZINC. CON MANIGLIA NERA M8	LEVER WITH BLACK KNOB M8
8030	FASCETTA NERA B4-190C 4,8X200	HOSE CLAMP BLACK B4-190C 4,8X200

MK8-75

**TABLE
TAVOLA D**

**RIGHT ROTOR
ROTORE DESTRO**

**BATTERY SIDE
LATO BATTERIA**

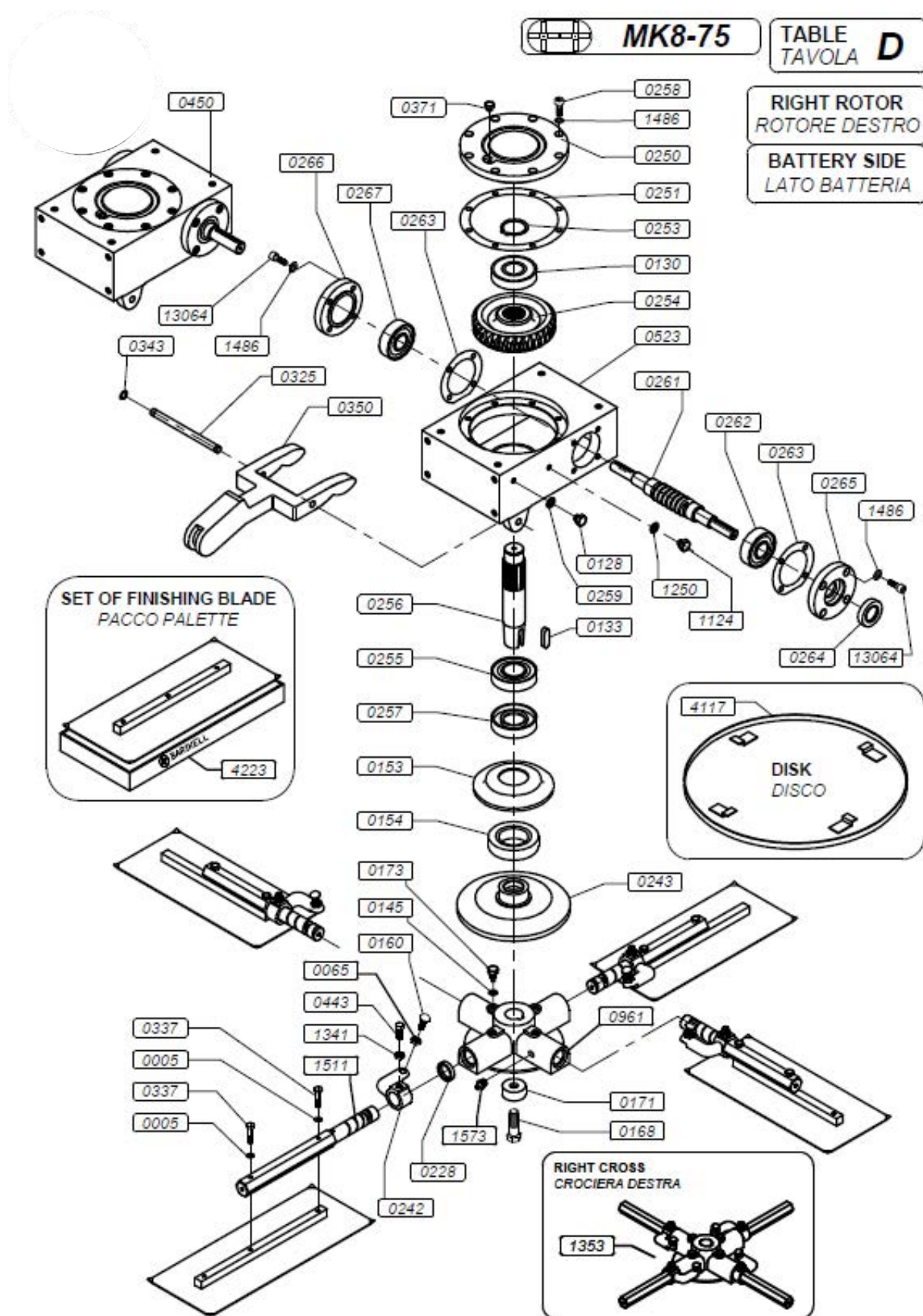

COD.	DESCRIZIONE (I)	DESCRIPTION (GB)
0005	RONDELLA GROWER D. 8 Z.B.	SCREW HEX HEAD 8x35 UNI 5737 GALVANIZED WHITE
0065	DADO M10 5588 Z.B.	NUT M10 5588
0128	TAPPO SCARICO OLIO 3/8" GAS ZB	PLUG OIL 3/8" GAS GALVANIZED WHITE
0130	CUSCINETTO CONICO 30306 CX	TAPER BEARING 30306 CX
0133	CHIAVETTA 10x8x35 - 6604A	KEY 10x8x35 - 6604A
0145	RONDELLA PIANA 10x21 6592 Z.B.	WASHER 10x21 6592 GALVANIZED WHITE
0153	COPRICUSCINETTO 4-90/4-120	COVER BEARING 4-90/4-120
0154	CUSCINETTO REGGISPINTA BCA2256	BEARING BCA2256
0160	VITE TTDE10X30 UNI 5731 SENZA	SCREW TTDE10X30 UNI 5731
0168	VITE TCCE 12x30X1,5 Z.B. DIN912	SCREW TCCE 12x30X1,5 GALVANIZED WHITE DIN912
0171	ROND. BLOCC. CROC. 4-90/120,MK8-75,OL90	WASHER 4-90/120,MK8-75,OL90
0173	VITE BLOC. BRAC.P.PALE 4-90/120	SCREW FIX TOOLHOLDER 4-90/120
0228	OR D.25 SEZ.1,5 PER CROC.	O-RING D.25 SEZ.1,5
0242	GOMITO GHISA D.25 4-90/MK8-75	BENG IN CAST IRON D.25 4-90/MK8-75
0243	CAMPANA REG.PALE D.182 ZB	UPPER HEAD TOOLHOLDER D.182
0250	COPERCHIOSUPERIORE V75	UPPER COVER V75
0251	GUARNIZIONE SUPERIORE V75	UPPER SEAL V75
0253	SEEGER "E" 30x1,5 UNI 7435 DIN 471	SEEGER "E" 30x1,5 UNI 7435 DIN 471
0254	CORONA DENTATA DX V75	CROWN GEAR DX V75
0255	CUSCINETTO SFERE 6207-2RS V75 CX	BALL BEARING 6207-2RS V75 CX
0256	ALBERO LENTO V75	SLOW SHAFT V75
0257	PARAOLIO DOP.TENUTA 35X55X10	OIL SEAL 35X55X10
0258	VITE TCCE 8x16 UNI 5931 Z.B. 12.9	SCREW TCCE 8x16 UNI 5931 GALVANIZED WHITE
0259	RONDELLA ALL. 17x23x1.5 X RID.	WASHER ALL. 17x23x1.5
0261	VITE SENZA FINE DX V75	WORM SCREW DX V75
0262	CUSCINETTO CONICO 30305 CX	TAPER BEARING 30305 CX
0263	GUARNIZIONE LATERALE V75	SEAL V75
0264	PARAOLIO DOP.TENUTA 25X45X10	OIL SEAL 25X45X10
0265	COPERCHIO LATERALE FORATO V75	PERFORATED SIDE LID V75
0266	COPERCHIO LATERALE CHIUSO V75	CLOSED SIDE COVER V75
0267	CUSCINETTO A SFERE 6305 CX	BALL BEARING 6305 CX
0325	PERNO FORCEL.D.11X179 Z.B.V75	PIN YOKE D.11X179 Z.B.V75
0337	VITE TE 8x40 5737 Z.B.	SCREW HEX HEAD 8x40 5737 GALVANIZED WHITE
0343	ANELLO RADIALE DIAM.10	SEAL DIAM.10
0350	FORCELLA COMANDO PALE D.11	YOKE CONTROL TOOLHOLDER D.11
0371	TAPPO SFIATO 1/8"+ RONDELLA IN RAME	BREATHER PLUG 1/8"+ COPPER WASHER
0443	GRANO M10x20 UNI 5927	DOWEL M10x20 UNI 5927
0450	RIDUTTORE COMPL.V75 DX S/MUS.	RH COMPLETE GEARBOX V75
0523	SCATOLA DX RID.V75 S/MUS OL90 MK8-75	RH REDUCTION GEAR BOX V75 S/MUS OL90 MK8-75
0803	VITE TCCE M8X20	SCREW TCCE M8X20
0961	CROCERA 4-90/MK8-75 C/FORI ING	SPIDER 4-90/MK8-75 C/FORI ING

1124	INDICAT.LIV.OLIO 3/4" VETRO	LEVEL INDICATOR OIL 3/4" GLASS
1250	RONDELLA ALL.27X33X1,5 3/4"	WASHER ALL.27X33X1,5 3/4"
13064	VITE TCCE 8x20 UNI 7984 Z.B.TESTA RIBAS	SCREW TCCE M8X20 UNI 7984 LOWERED HEAD
1341	DADO M10 5589 BASSO GREZZO	NUT M10 5589
1353	CROCERA COMP.DX MK8-75 C/ING	COMPLETE RH SPIDER PLATE MK8-75
1486	RONDELLA ZIGRINATA D.8 Z.B.	WASHER D.8 GALVANIZED WHITE
1511	BRACCIO PORTA PALETTA MK8-75	TOOLHOLDER ARM MK8-75
1573	INGRASSATORE M8X1.25 2802	GREASE FITTING M8X1.25 2802
4117	DISCO FRAT.D.750 MK8-75 4 LING	TROWEL DISC D.750 MK8-75 4 LING
4223	PACCO PALETTE 4-80/MK8-75	SET OF FINISHING BLADES 4-80/MK8-75

MK8-75

TABLE
TAVOLA **E**

LEFT ROTOR
ROTORE SINISTRO

ENGINE SIDE
LATO MOTORE

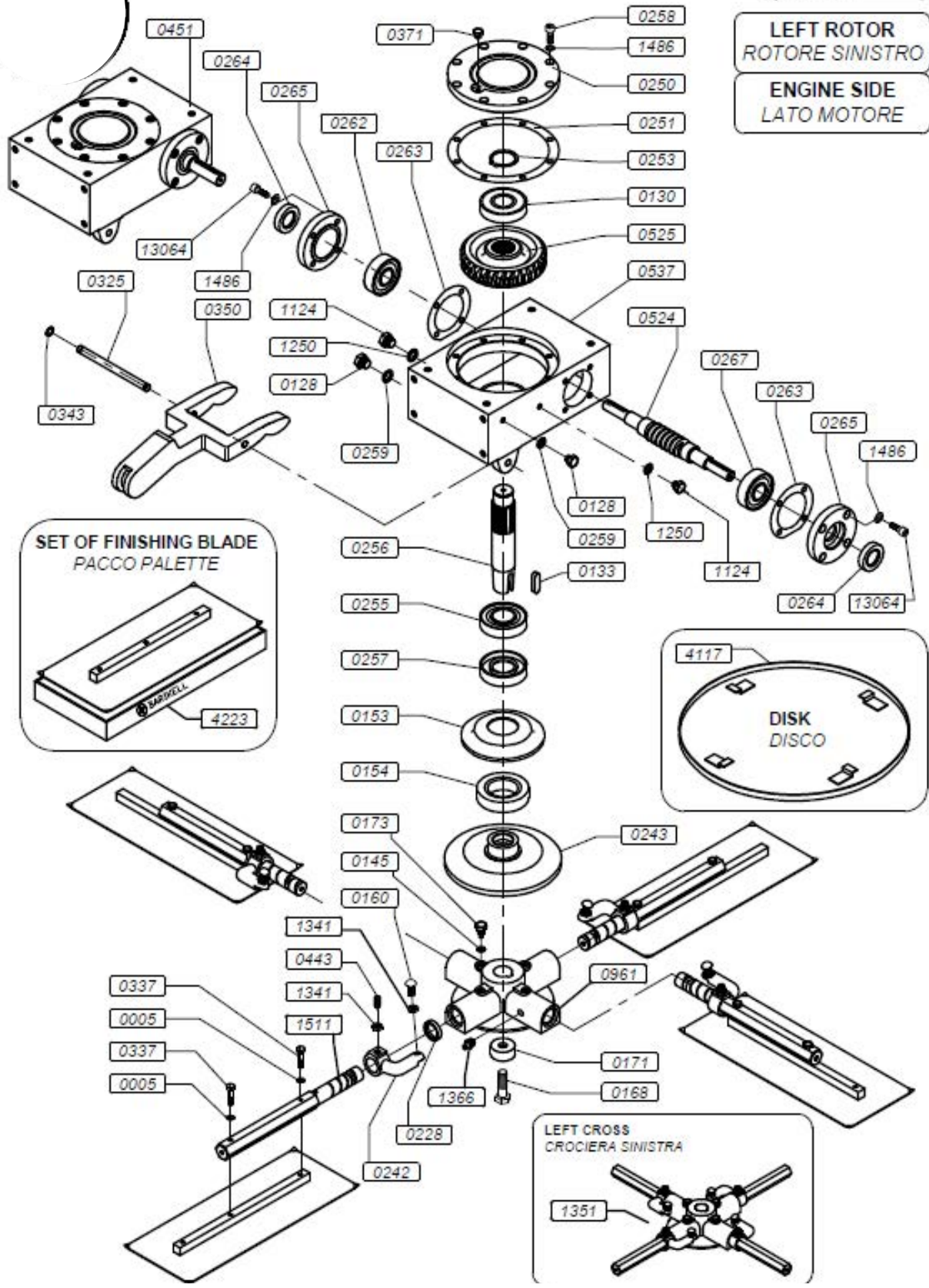

COD.	DESCRIZIONE (I)	DESCRIPTION (GB)
0005	RONDELLA GROWER D. 8 Z.B.	SCREW HEX HEAD 8x35 UNI 5737 G. WHITE
0128	TAPPO SCARICO OLIO 3/8" GAS ZB	PLUG OIL 3/8" GAS GALVANIZED WHITE
0130	CUSCINETTO CONICO 30306 CX	TAPER BEARING 30306 CX
0133	CHIAVETTA 10x8x35 - 6604A	KEY 10x8x35 - 6604A
0145	RONDELLA PIANA 10x21 6592 Z.B.	WASHER 10x21 6592 GALVANIZED WHITE
0153	COPRICUSCINETTO 4-90/4-120	COVER BEARING 4-90/4-120
0154	CUSCINETTO REGGISPINTA BCA2256	BEARING BCA2256
0160	VITE TTDE10X30 UNI 5731 SENZA	SCREW TTDE10X30 UNI 5731
0168	VITE TCCE 12x30X1,5 Z.B. DIN912	SCREW TCCE 12x30X1,5 GALVANIZED WHITE
0171	ROND. BLOCC. CROC.	WASHER 4-90/120,MK8-75,OL90
0173	VITE BLOC.BRAC.P.PALE 4-90/120	SCREW FIX TOOLHOLDER 4-90/120
0228	OR D.25 SEZ.1,5 PER CROC.	O-RING D.25 SEZ.1,5
0242	GOMITO GHISA D.25 4-90/MK8-75	BENG IN CAST IRON D.25 4-90/MK8-75
0243	CAMPANA REG.PALE D.182 4-90 ZB	UPPER HEAD TOOLHOLDER D.182 4-90 ZB
0250	COPERCHIOSUPERIORE V75	UPPER COVER V75
0251	GUARNIZIONE SUPERIORE V75	UPPER SEAL V75
0253	SEEGER "E" 30x1,5 UNI 7435 DIN 471	SEEGER "E" 30x1,5 UNI 7435 DIN 471
0255	CUSCINETTO SFERE 6207-2RS V75 CX	BALL BEARING 6207-2RS V75 CX
0256	ALBERO LENTO V75	SLOW SHAFT V75
0257	PARAOLIO DOP.TENUTA 35X55X10	OIL SEAL 35X55X10
0258	VITE TCCE 8x16 UNI 5931 Z.B. 12.9	SCREW TCCE 8x16 UNI 5931 G. WHITE
0259	RONDELLA ALL. 17x23x1.5 X RID.	WASHER ALL. 17x23x1.5
0262	CUSCINETTO CONICO 30305 CX	TAPER BEARING 30305 CX
0263	GUARNIZIONE LATERALE V75	SEAL V75
0264	PARAOLIO DOP.TENUTA 25X45X10	OIL SEAL 25X45X10
0265	COPERCHIO LATERALE FORATO V75	PERFORATED SIDE LID V75
0267	CUSCINETTO A SFERE 6305 CX	BALL BEARING 6305 CX
0325	PERNO FORCEL.D.11X179 Z.B.V75	PIN YOKE D.11X179 Z.B.V75
0337	VITE TE 8x40 5737 Z.B.	SCREW HEX HEAD 8x40 5737 G.WHITE
0343	ANELLO RADIALE DIAM.10	SEAL DIAM.10
0350	FORCELLA COMANDO PALE D.11	YOKE CONTROL TOOLHOLDER D.11
0371	TAPPO SFIATO 1/8"+ RONDELLA IN RAME	BREATHER PLUG 1/8"+ COPPER WASHER
0443	GRANO M10x20 UNI 5927	DOWEL M10x20 UNI 5927
0451	RIDUTTORECOMPL.V75 SX S/MUS.	LH COMPLETE GEARBOX V75
0524	VITE S/FINE SX RIDUTTORE V75	LH WORM SCREW V75
0525	CORONA DENTATA SX RIDUTT. V75	LH CROWN GEAR V75
0537	SCATOLA SX RID.V75 S/MUS OL90	LH REDUCTION GEAR BOX V75 S/MUS
0803	VITE TCCE M8X20	SCREW TCCE M8X20
0961	CROCERA 4-90/MK8-75 C/FORI ING	SPIDER 4-90/MK8-75 C/FORI ING
1124	INDICAT.LIV.OLIO 3/4" VETRO	LEVEL INDICATOR OIL 3/4" GLASS
1250	RONDELLA ALL 27X33X1,5 3/4"	WASHER ALL 27X33X1,5 3/4"
13064	VITE TCCE 8x20 UNI 7984 Z.B.TESTA RIBAS	SCREW TCCE M8X20 UNI 7984 LOWERED HEAD

1341	DADO M10 5589 BASSO GREZZO	NUT M10 5589
1351	CROCERA COMP.SX MK8-75 C/ING	LH COMPLETE SPIDER PLATE MK8-75
1366	INGRASSATORE M8X1,25	GREASE FITTING M8X1,25
1486	RONDELLA ZIGRINATA D.8 Z.B.	WASHER D.8 GALVANIZED WHITE
1511	BRACCIO PORTA PALETTA MK8-75	TOOLHOLDER ARM MK8-75
4117	DISCO FRAT.D.750 MK8-75 4 LING	TROWEL DISC D.750 MK8-75 4 LING
4223	PACCO PALETTE 4-80/MK8-75	SET OF FINISHING BLADES 4-80/MK8-75

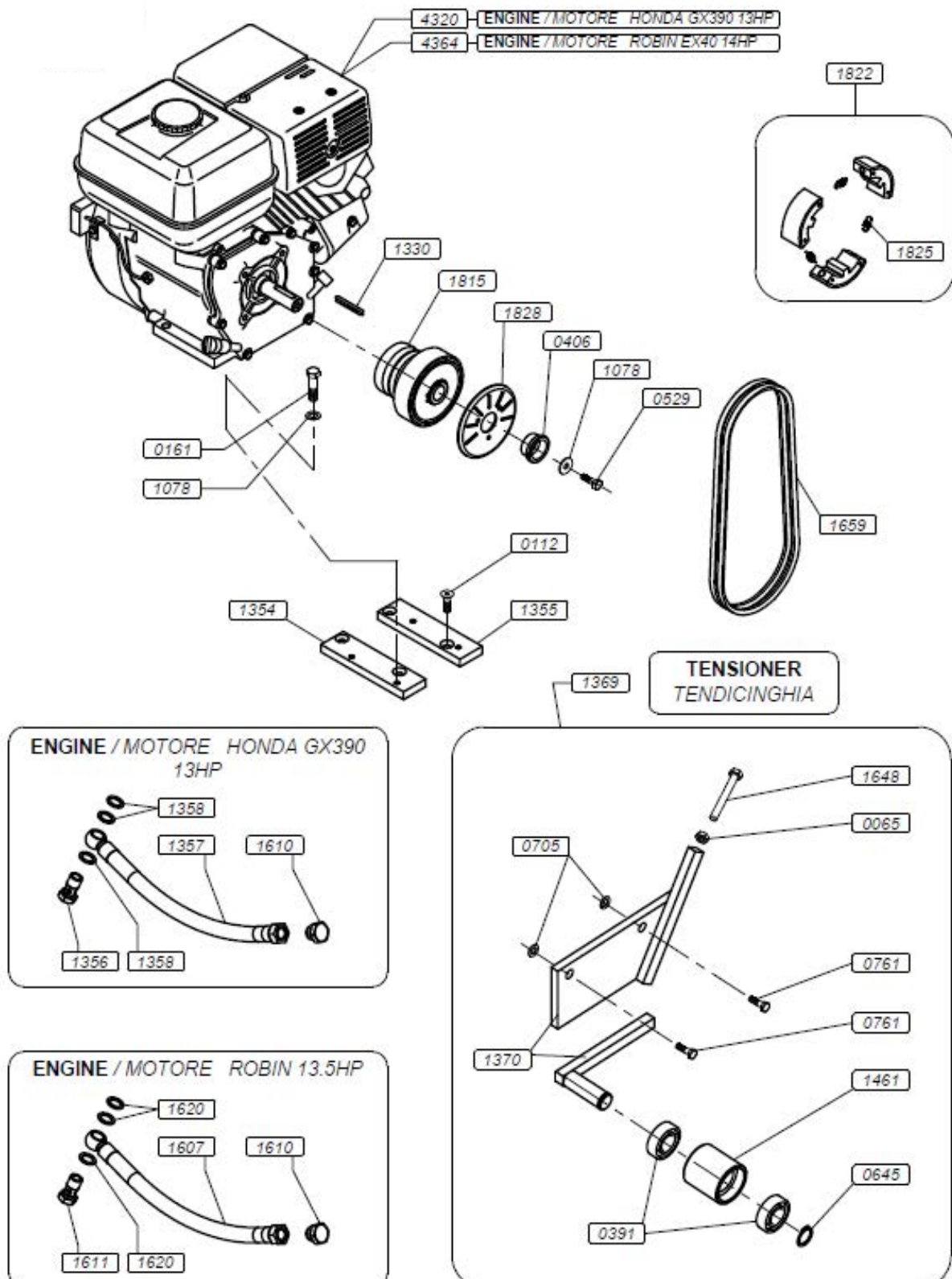

COD.	DESCRIZIONE (I)	DESCRIPTION (GB)
0065	DADO M10 5588 Z.B.	NUT M10 5588 GALVANIZED WHITE
0112	VITE VSP 10x40 5933 ZINC. BIANCA	SCREW VSP 10x40 5933 GALVANIZED WHITE
0161	VITE TE 10x35 5737 Z.B.	SCREW TE 10x35 5737 GALVANIZED WHITE
0391	CUSCINETTO 6004 2RS 42-12 TEND	BEARING 6004 2RS 42-12
0406	BOCCOLA FISSAG. FRIZ. PAF 105	FIX BUSHING FRICTION PAF 105
0529	VITE TE UNF 3/8x1"3/4	SCREW HEX HEAD UNF 3/8x1"3/4
0645	SEEGER "E" 20 - 7435	SEEGER "E" 20 - 7435
0705	RONDELLA PIANA D. 8 Z.B.	WASHER D. 8 GALVANIZED WHITE
0761	VITE TE UNF 5/16x1	SCREW HEX HEAD UNF 5/16x1
1078	RONDELLA ZIGRIN.D10 ZINC.B.	WASHER D10 GALVANIZED WHITE
1330	CHIAVETTA 38X6, 35X6	KEY 38X6, 35X6
1354	SUPPORTO MOTORE ANTER.	FRONT SUPPORT ENGINE
1355	SUPPORTO MOTORE POSTER.	REAR SUPPORT ENGINE
1356	BULLONE FORATO 12X1,5mm TUBO SCAR.OLIO	BOLT HOLE 12X1,5mm PIPE OIL
1357	TUBO T.PLAS.R7 1/4" FD3/8"-1/4	PIPE R7 1/4" FD3/8"-1/4
1358	RONDELLA RAME 12X18X1,5 PER BULLONE FOR.	WASHER COPPER 12X18X1,5
1369	TENDICINGHIA COMPLETO MK8-75	COMPLETE BELT TENSIONER MK8-75
1370	TENDICINGHIA PER MK8-75	BELT STRETCHER FOR MK8-75
1461	PULEGGIA ALL. D.EST.70 L=50	PULLEY ALL. D.EST.70 L=50
1607	TUBO T.PLAS.R7 1/4" FD3/8"-1/4	PIPE R7 1/4" FD3/8"-1/4
1610	TAPPO TESTA ESAGONALE GAS 3/8"	HEX HEAD CAP GAS 3/8"
1611	BULLONE FORATO 14X1.5mm X TUBO SCAR.OLIO	BOLT HOLE 14X1.5mm FOR PIPE OIL
1620	RONDELLA RAME 14X20X1,5	WASHER COPPER 14X20X1,5
1648	VITE TE 10X75 5739 Z.B. TUT.FI	SCREW HEX HEAD 10X75 5739 GALVANIZED WHITE
1659	CINGHIA OPTIBELT XPA 807	BELT OPTIBELT XPA 807
1815	FRIZIONE 4-90/120 105 D.25,4 (1")	CLUTCH 4-90/120 105 D.25,4 (1")
1822	SERIE MASSE FRIZIONE BARIKELL	FLYWEIGHT FOR CLUTCH BARIKELL
1825	MOLLA X FRIZIONE BARIKELL 105	SPRING FOR CLUTCH BARIKELL 105
1828	COPERCHIO FRIZIO.BARIKELL 105	CLUTCH COVER BARIKELL 105
4320	MOTORE HONDA GX390UT2 13HP A/S	ENGINE HONDA GX390UT2 13HP A/S
4364	MOTORE ROBIN EX40 14HP A/ELET.	ENGINE ROBIN EX40 14HP A/ELET.

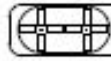

MK8-75

**TABLE
TAVOLA F2**

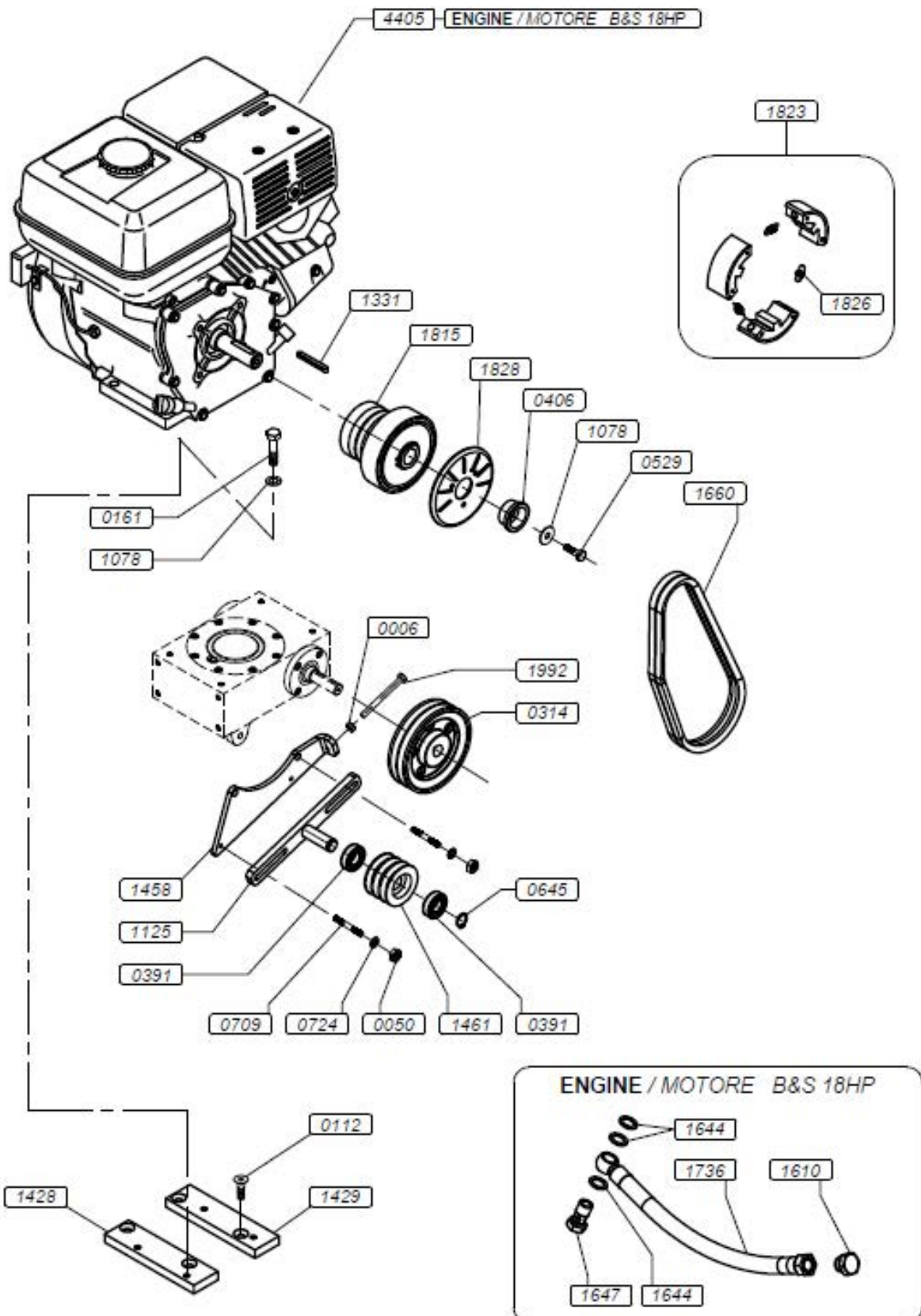

COD.	DESCRIZIONE (I)	DESCRIPTION (GB)
0006	DADO M8 UNI 5588 Z.B.	NUT M8 UNI 5588
0050	DADO BLOKM8 DIN 985 Z.B.	BLOK NUT M8 DIN 985
0112	VITE VSP 10x40 5933 ZINC. BIANCA	SCREW VSP 10x40 5933 GALVANIZED WHITE
0161	VITE TE 10x35 5737 Z.B.	SCREW TE 10x35 5737 GALVANIZED WHITE
0314	PULEGGIA 140x2A D.20H7	PULLEY 140X2A D.20H7
0391	CUSCINETTO 6004 2RS 42-12 TEND	BEARING 6004 2RS 42-12
0406	BOCCOLA FISSAG. FRIZ. PAF 105	FIX BUSHING FRICTION PAF 105
0529	VITE TE UNF 3/8x1"3/4	SCREW HEX HEAD UNF 3/8x1"3/4
0645	SEEGER "E" 20 - 7435	SEEGER "E" 20 - 7435
0709	PRIGIONIERO M8 L=40 Z.B.	TIE ROD M8 L=40
0724	RONDELLA 8x24 - ZINCATA BIANCA	WASH PLAIN 8X24
1078	RONDELLA ZIGRIN.D10 ZINC.B.	WASHER D10 GALVANIZED WHITE
1125	BRACCIO + PERNO PIASTRA TENDICINGHIA	ARM + BELT TENSIONER PIN
1331	CHIAVETTA	KEY
1428	SUPPORTO MOTORE ANTER.	FRONT SUPPORT ENGINE
1429	SUPPORTO MOTORE POSTER.	REAR SUPPORT ENGINE
1458	TENDICINGHIA PIASTRA	BELT TENSIONER PLATE
1461	PULEGGIA ALL. D.EST.70 L=50	PULLEY ALL. D.EST.70 L=50
1610	TAPPO TESTA ESAGONALE GAS 3/8"	HEX HEAD CAP GAS 3/8"
1644	BULLONE FORATO 14X1.5mm X TUBO SCAR.OLIO	BOLT HOLE 14X1.5mm FOR PIPE OIL
1647	BULLONE FORATO GAS 3/8" CH.22	BOLT 3/8" CH.22
1661	CINGHIA OPTIBELT XPA 850	BELT OPTIBELT XPA 850
1736	TUBO FLEXR6 3/8" FD. 3/8" +	FLEX PIPE R6 3/8" FD. 3/8"
1815	FRIZIONE 4-90/120 105 D.25,4 (1")	CLUTCH 4-90/120 105 D.25,4 (1")
1822	SERIE MASSE FRIZIONE BARIKELL	FLYWEIGHT FOR CLUTCH BARIKELL
1825	MOLLA X FRIZIONE BARIKELL 105	SPRING FOR CLUTCH BARIKELL 105
1828	COPERCHIO FRIZIO.BARIKELL 105	CLUTCH COVER BARIKELL 105
1992	VITE TE 8X70 UNI 5739 Z.B.	SCREW TE 8X70 UNI 5739
4405	MOTORE B&S.VAN.18HP C/SERB.	B&S VANGUARD ENGINE 18HP WITH TANK

OPTIONAL



MK8-75

**TABLE
TAVOLA**

G

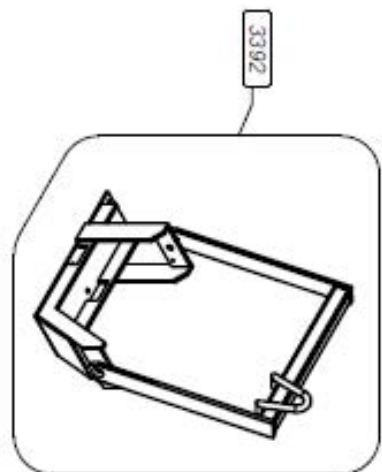
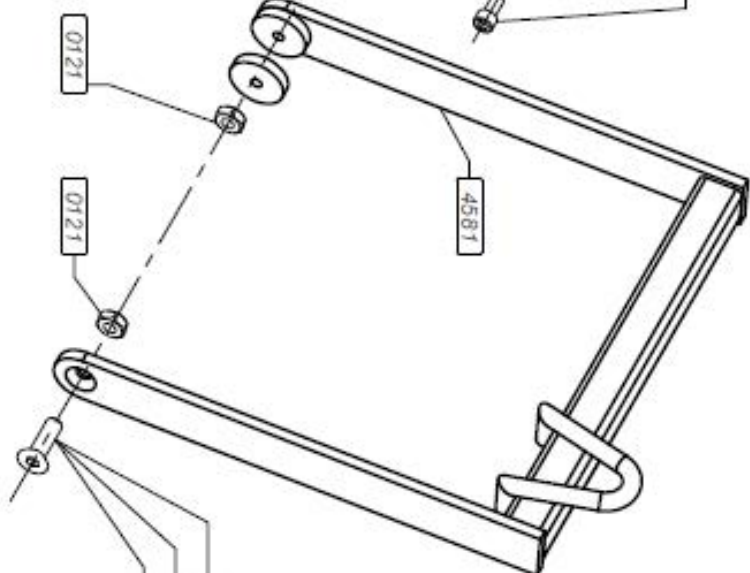
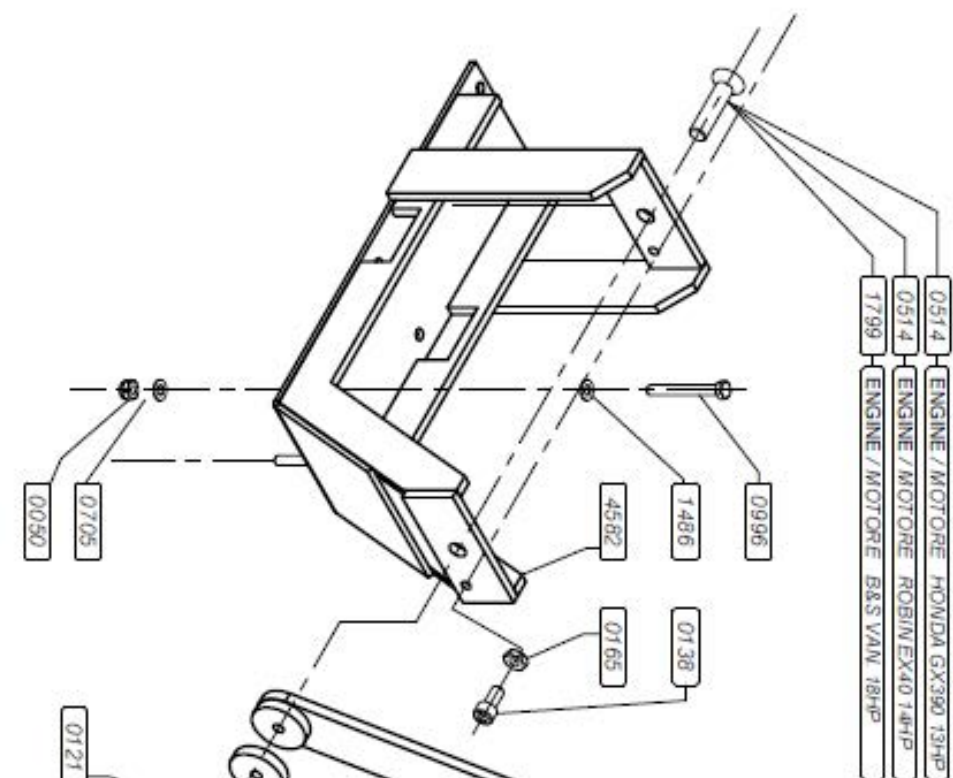

COD.	DESCRIZIONE (I)	DESCRIPTION (GB)
0050	DADO BLOKM8 DIN 985 Z.B.	SCREW HEX HEAD 8x20 UNI 5739 GALVANIZED WHITE
0121	DADO BLOKM14 BASSO 7474 Z.B	SELF-LOCKING NUT M14 7474 GALVANIZED WHITE
0138	VITE TCCE 10x20 Z.B. UNI 5931	SCREW 10x20 UNI 5931
0165	DADO M10 5589 BASSO - Z.B.	NUT M10 5589
0514	VITE TE 14x40 5739 ZB	SCREW HEX HEAD M14x40 5739 GALVANIZED WHITE
0705	RONDELLA PIANA D. 8 Z.B.	WASHER D. 8 GALVANIZED WHITE
0714	VITE VSP 14x45 5933 ZB	SCREW VSP M14x45 5933 GALVANIZED WHITE
0996	VITE TE 8x90 UNI 5739 DIN 933 Z.B.	SCREW 8x90 UNI 5739 DIN 933
1486	RONDELLA ZIGRINATA D.8 Z.B.	WASHER D.8 GALVANIZED WHITE
1799	VITE TE 14X55 UNI 5737 Z.B.	SCREW HEX HEAD 14X55 UNI 5737 GALVANIZED WHITE
3392	GANCIO SOLLEVAMENTO COMPLETO	COMPLETE LIFTING HOOK OL90/MK8-75
4581	GANCIO SOLLEVAM. PARTE SUPER.OL90/MK8-75	TOP LIFTING HOOK OL90/MK8-75
4582	ATTACCO GANCIO SOLLEVAM. OL90/MK8-75	LIFTING HOOK CONNECTION OL90/MK8-75

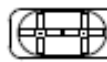

MK8-75

TABLE
TAVOLA **H**

ELECTRICAL SCHEME 12V FOR DOUBLE

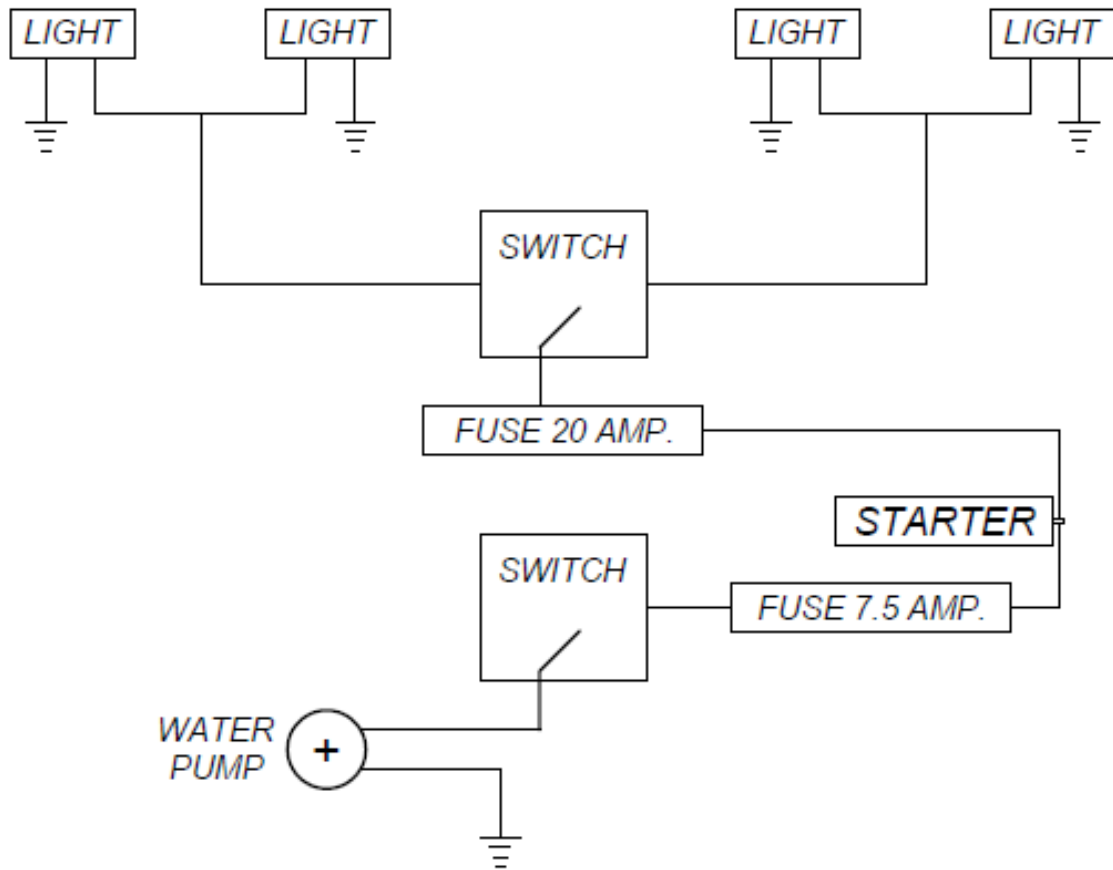

SWITCH SEAT

EMERGENCY

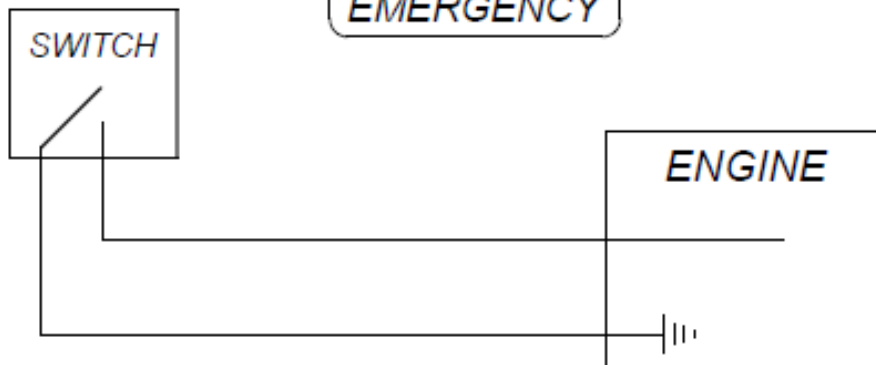

6.6 WARRANTY

1. **MBW** warrants each new machine against defects in material and workmanship under normal use and service for a period of six (6) months. This warranty commences the first day the machine is sold, assigned to a rental fleet, or otherwise put to first use.
2. The obligation under this warranty is limited to the replacement or repair of parts and/or machine at **MBW** factory branches or at authorized **MBW** distributors.
3. Machines altered or modified without **MBW** written consent voids this warranty. Misuse, negligence, accidents or the operation of machines in any way other than recommended by **MBW** will void this warranty. This warranty shall not apply to machines repaired by other than **MBW** factory branches or authorized **MBW** distributors.
4. This warranty includes labor on all **MBW** products. Labor must be performed at an authorized **MBW** distributor.
5. The cost of transportation and other expenses connected therewith are not covered by this warranty.
6. Written authorization for the return of merchandise under warranty must be obtained from **MBW** or **MBW (UK) Limited**.
7. **MBW** reserves the right to inspect and render final decision on each warranty case.
8. **MBW** reserves the right to improve or make product changes without incurring any obligation to update, refit, or install the same on machines previously sold.
9. **MBW** is not responsible for any liability or damage or injury directly or indirectly from design, material or operation of its products.
10. Warranty card must be returned to **MBW** or **MBW (UK) Limited** within 10 days after purchase, assignment to a rental fleet, or first use. Failure to return warranty card as specified renders the warranty null and void.
11. Requests for warranty must be submitted within 30 days after machine failure to **MBW** or **MBW (UK) Limited**.
12. The foregoing warranty is expressly in lieu of all other warranties, expressed or implied, including the warranties of merchantability and fitness for use, and of all other obligation or liabilities on our part, and we neither assume nor authorize any other person to assume for us any other liability or warranty in connection with the sale or service of any of our products. Likewise, this warranty shall not apply with respect to engines, motors and other component parts produced by other manufactures and used on **MBW** products, but such items shall have such warranties as may be provided by the manufacturer thereof.

No part of this publication may be reproduced, stored in a retrieval system or transmitted in any form or by any means to third parties, without the prior written consent of the Manufacturer.